



AE***JXYDGH
AE***JXYDEH

Air to Water Heat Pump Mono Outdoor Unit installation manual

imagine the possibilities

Thank you for purchasing this Samsung product.

Contents

Safety precautions	3
Product specifications	5
Outdoor unit specification	6
Application examples	7
Main components	8
Functional diagram	12
Installing the unit	13
Piping work	22
Wiring	28
Testing operations	36
Error codes	38
Maintenance	40
Charging refrigerant	43
Troubleshooting	44
Commissioning	47
Recommissioning instructions	47
COMMISSION REGULATION (EU) No 813/2013 ¹⁾	48
COMMISSION DELEGATED REGULATION (EU) No 811/2013 ¹⁾	68

Safety precautions

Carefully follow the precautions listed as below because they are essential to guarantee the safety of SAMSUNG product.



WARNING

- Always disconnect a power supply of Air-Water Heat Pump before servicing it or accessing components inside the unit.
- Verify that installation and testing operations shall be performed by qualified personnel.
- To prevent serious damage on the system and injuries to users, precautions and other notices shall be observed.

Warning



- ▶ Carefully read the content of this manual before installing the air to water heat pump and store the manual in a safe place in order to be able to use it as reference after installation.
- ▶ For maximum safety, installers should always carefully read the following warnings.
- ▶ Store the provided manual in a safe location with end user after installation, and remember to hand it over to the new owner if the Heat pump unit is sold or transferred.
- ▶ This manual explains how to install Air-Water Heat Pump. The use of other types of units with different control systems may damage the units and invalidate the warranty. The manufacturer shall not be responsible for damages arising from the use of non compliant units.
- ▶ The manufacturer shall not be responsible for damage originating from unauthorized changes or the improper connection of electric and hydraulic lines. Failure to comply with these instructions or to comply with the requirements set forth in the "Operating limits" table, included in the manual, shall immediately invalidate the warranty.
- ▶ Failure to comply with these instructions or to comply with the requirement on the Operating Range (Heat: -25~35°C/ Cool: 10~46°C) set forth in the Product Specification (p.5) shall immediately invalidate the warranty.
- ▶ Do not use the units if you see some damages on the units and recognize something bad such as loud noisy, smell of burning.
- ▶ In order to prevent electric shocks, fires or injuries, always stop the unit, disable the protection switch and contact SAMSUNG's technical support if the unit produces smoke, if the power cable is hot or damaged or if the unit is very noisy.
- ▶ Always remember to inspect the unit, electric connections, refrigerant tubes and protections regularly. These operations shall be performed by qualified personnel only.
- ▶ The unit contains moving parts and electrical parts, which should always be kept out of the reach of children.
- ▶ Do not attempt to repair, move, alter or reinstall the unit by unauthorized personnel, these operations may cause product damage, electric shocks and fires.
- ▶ Do not place containers with liquids or other objects on the unit.
- ▶ All the materials used for the manufacture and packaging of the air to water heat pump are recyclable.
- ▶ The packing material and exhaust batteries of the remote controller(optional) must be disposed of in accordance with local regulations.
- ▶ The air to water heat pump contains a refrigerant that has to be disposed of as special waste. At the end of its life cycle, the heat pump must be disposed of in authorized centers or returned to the retailer so that it can be disposed of correctly and safely.
- ▶ Wear protective gloves to unpack, move, install, and service the unit to avoid your hands being injured by the edge of the parts.
- ▶ Do not touch the internal parts (water pipes, refrigerant pipes, heat exchangers, etc) while running the units. And if you need to adjust and touch the units, have enough time for the unit can be cooled and be sure to wear protective gloves.
- ▶ In case of refrigerant leakage, try to avoid getting in contact with the refrigerant because this could result in severe wounds.
- ▶ When you install the Air to water heat pump in a small room, you must consider a proper ventilation to prevent a leakage level within the maximum permissible limit.
 - In that case, you may die from suffocation by some possibility.

Safety precautions

- ▶ Make sure to safely dispose of packing materials. Packing materials, such as nails and other metal or wooden pallets may cause children get injured.
- ▶ Inspect the product shipped and check if damaged during transport. If the product has some damages, DO NOT INSTALL and immediately discuss about the damages with the carrier or retailer (if the installer or the authorized technician has collected the material from the retailer.)
- ▶ Our units shall be installed in compliance with the spaces described in the installation manual, to ensure accessibility from both sides and allow repairs or maintenance operations to be carried out. If the units installed without complying with procedures described in manual, additional expenses can be asked because special harnesses, ladders, scaffolding or any other elevation system for repair service will NOT be considered part of the warranty and will be charged to the end customer.
- ▶ Always make sure that the power supply is compliant with local safety standards.
- ▶ Verify that the voltage and frequency of the power supply comply with the specifications and input power is sufficient to ensure the operation of any other domestic appliance connected to the same electric lines. Always verify that the cut-off and protection switches are suitably selected.
- ▶ Always verify that electric connections (cable entry, section of leads, protections . . .) are compliant with the electric specifications and with the instructions provided in the wiring scheme. Always verify that all connections comply with the standards applicable to the installation of air to water heat pumps. Devices disconnected from the power supply should be completely disconnected in the condition of overvoltage category.
- ▶ Do not connect the earth wire to the gas pipe or water pipe, lighting rod, surge absorber, or telephone earth wire. If earthing is not complete, it may cause an electric shock or fire.
- ▶ Be sure to install both an earth leakage detector and circuit breaker with specified capacity in accordance with relevant local and national regulations.
 - If it is not installed properly, it may cause electric shocks and fire.
- ▶ Make sure that the condensed water runs well out of the unit at low ambient temperature. Drain pipe and cond heater can frost/ice can not grow. If drain work is not effective for releasing condensed water, it can make the units get damaged by massive ice and system can be stop , covered by ice.
- ▶ Install the power cable and communication cable of the indoor and outdoor unit at least 1m away from the electric appliance.
- ▶ Protect the unit from rats or small animals. If an animal makes a contact with the electric parts, it can cause malfunctions, smoke or fire. Please instruct the customer to keep the area around the unit clean.
- ▶ Do not disassemble and alter the heater at your own discretion.
- ▶ Be sure not to perform power cable modification, extension wiring, and multiple wire connection.
 - It may cause electric shock or fire due to poor connection, poor insulation, or current limit override.
 - When extension wiring is required due to power line damage, refer to "How to connect your extended power cables" in the installation manual.



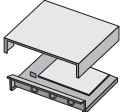

Product specifications

Product line-up

Line-up				Remark
Heat pump units	Chassis			
	Model name	AE090JXYDEH AE090JXYDGH	AE120JXYDEH AE120JXYDGH AE140JXYDEH AE140JXYDGH AE160JXYDEH AE160JXYDGH	
Auxiliary parts	 Control kit	MIM-E03AN		Requisite

Accessories

- ▶ Keep supplied accessories until the installation is finished.
- ▶ Hand the installation manual over to the customer after finishing installation.
- ▶ The quantities are indicated in parentheses.

Installation manual (1)	Drain plug (1)	Rubber Leg(4)	Drain cap (3)
			

Outdoor unit specification

Type	Unit	AE090JXYDEH AE090JXYDGH	AE120JXYDEH AE120JXYDGH	AE140JXYDEH AE140JXYDGH	AE160JXYDEH AE160JXYDGH
Power source	-	1Φ, 220~240VAC 50Hz 3Φ, 380~415VAC 50Hz	1Φ, 220~240VAC 50Hz 3Φ, 380~415VAC 50Hz	1Φ, 220~240VAC 50Hz 3Φ, 380~415VAC 50Hz	1Φ, 220~240VAC 50Hz 3Φ, 380~415VAC 50Hz
Refrigerant	g	1,400(R-410A) 1,500(R-410A)	2,600(R-410A)	2,600(R-410A)	2,600(R-410A)
Noise (Heat/Cool, Pressure)	dB(A)	48/48	50/50	51/52	52/54
Water connection (In/Out)	Inch	1.0	1.0	1.0	1.0
Leaving water temperature	°C	Cooling : 5~25 Heating : 25~55	Cooling : 5~25 Heating : 25~55	Cooling : 5~25 Heating : 25~55	Cooling : 5~25 Heating : 25~55
Operating range (Heat/Cool)	°C	-25~35/10~46	-25~35/10~46	-25~35/10~46	-25~35/10~46
Weight (net/gross)	kg	76/84	108/118	108/118	108/118
Size (WxHxD, net)	mm	940 x 998 x 330	940 x 1,420 x 330	940 x 1,420 x 330	940 x 1,420 x 330

* At the temperature -25 °C ~ -20 °C, operation is available but capacity cannot be guaranteed.

Application examples



WARNING

- The application examples given below are for illustration purposes only.
- When the SAMSUNG Air-to-Water Heat Pump system is used in series with another heat source (e.g. gas boiler), ensure that the return water temperature not exceed 55°C.
- The unit is only to be used in a closed water system. Application in an open water circuit can lead to excessive corrosion of the water piping.
- SAMSUNG can not be put responsible for incorrect or unsafe situations in the water system. Make sure that the boiler, radiators, convectors, solar collectors, UFHs, FCUs, additional pumps, pipings, and controls in the water system are in accordance with relevant local laws and regulations under the installer's responsibility.
- By-pass valve shall be installed for space heating loops. When one of loops or all loops are closed, water flow rate could be low condition. To keep flow rate approximately and prevent flow stop, the by-pass valve shall be installed between supply collector and return collector.
- SAMSUNG shall not be held liable for any damage resulting from not observing this rule.
- SAMSUNG do not provide specific water system components such as Pressure relief valve, Air vent valve, buffer tank and etc. Installers and end-users shall consider how to install the above designated components in overall water system depending on the installation conditions. If the components are not installed in appropriate location, the water system can not be operated as designed.

Application #1

Mono outdoor + Control kit

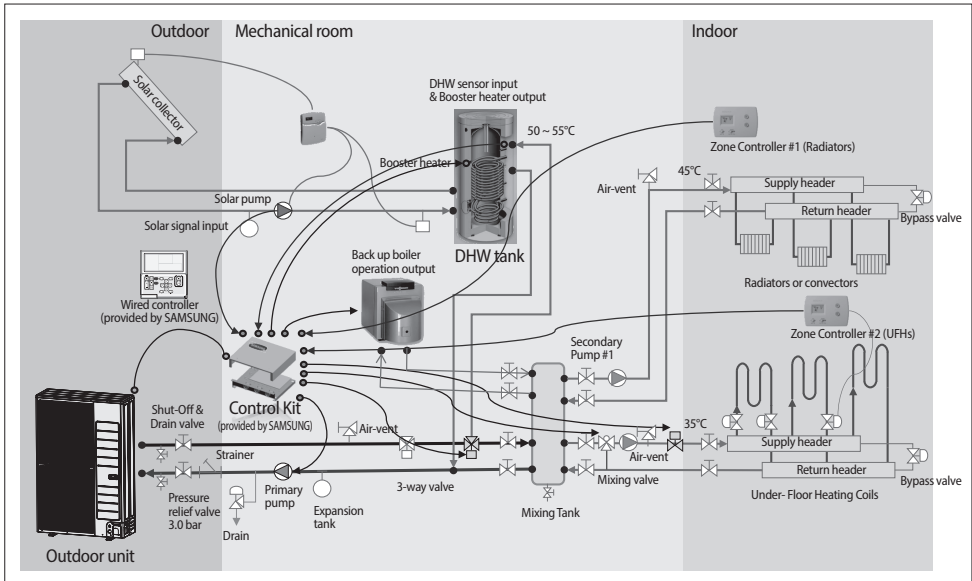

Main components

Dimensions(Overall)

Heat pump for R-410A.

1-Fan chassis

▶ AE090JXYD*

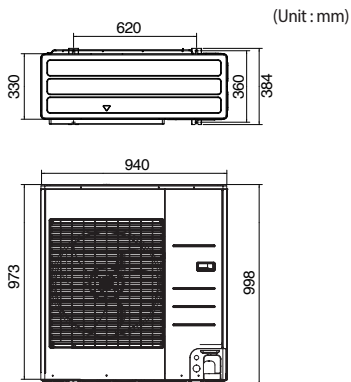
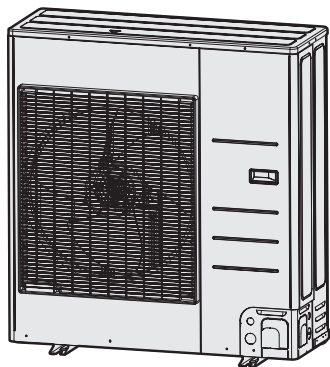

2-Fan chassis

▶ AE120JXYD*/AE140JXYD*/AE160JXYD*

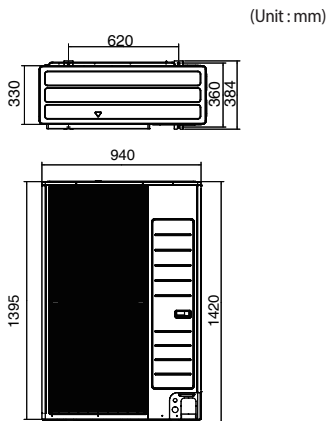

Dimensions (Water pipe)

AE090JXYD*

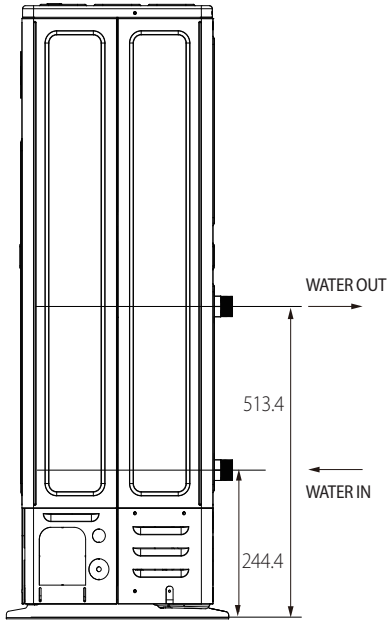

(Unit : mm)

AE120JXYD*/AE140JXYD*/AE160JXYD*

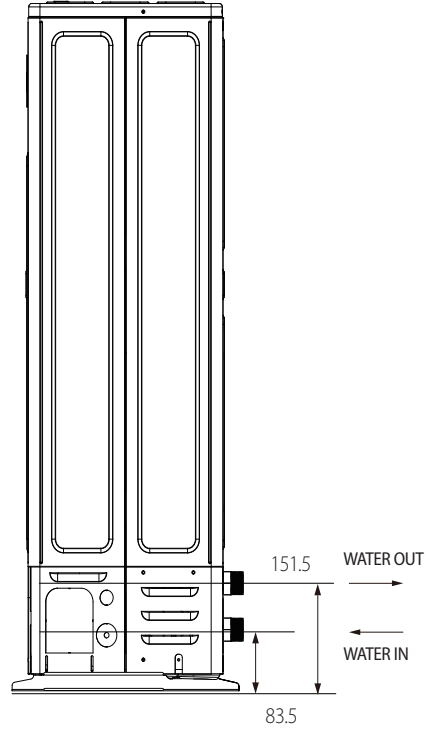

(Unit : mm)

Main components

AE090*

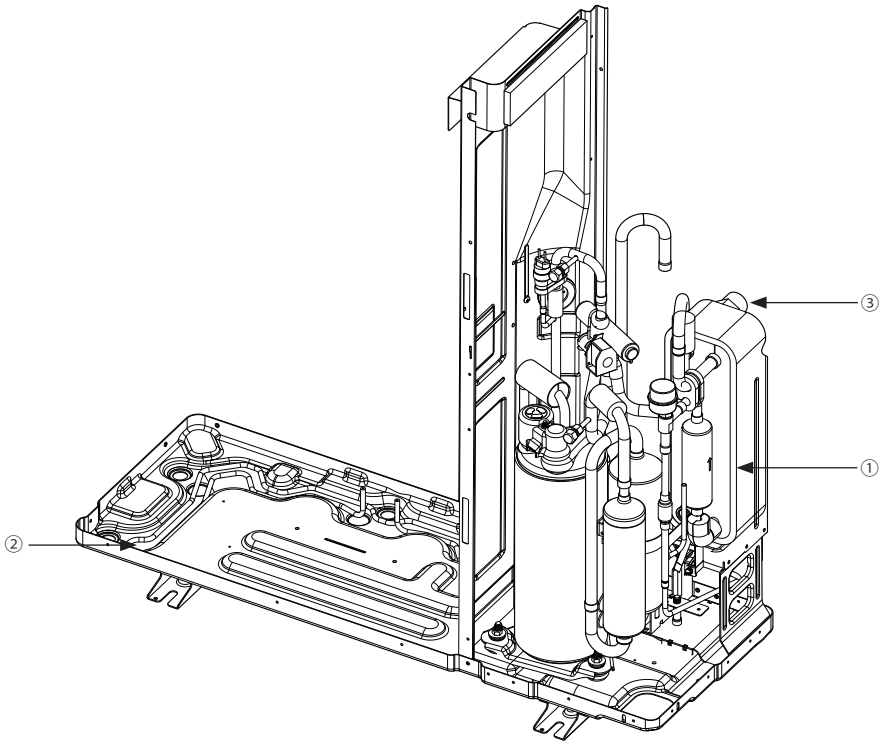

NO.	Name	Note.
①	PHE	Danfoss, H30L series
②	Base heater	SUS316L, 150W
③	Water fitting	BSPP 1" Male

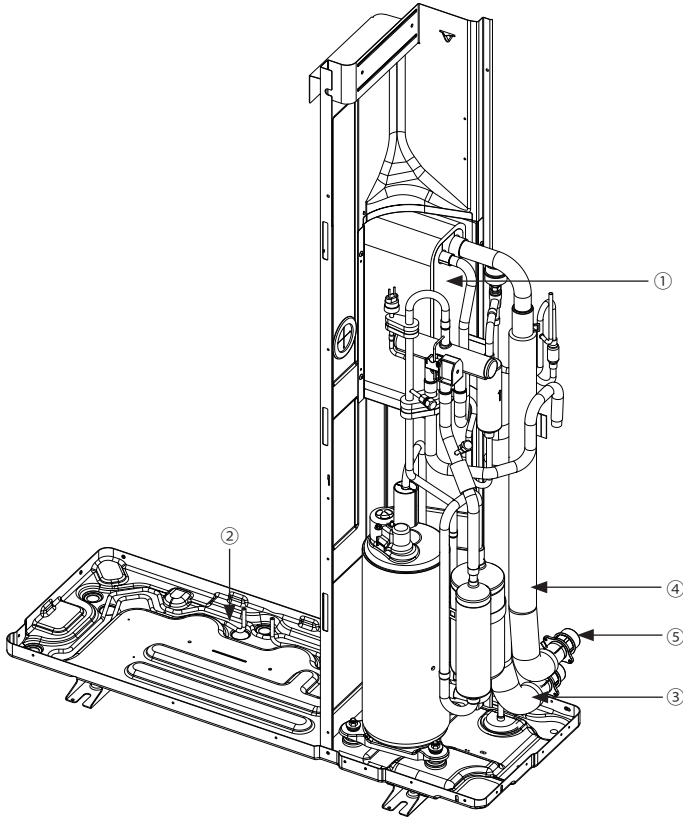

NO.	Name	Note.
①	PHE	Danfoss, B3-030 series
②	Base heater	SUS316L, 150W
③	Water hose in	Rubber hose
④	Water hose out	Rubber hose
⑤	Water fitting	BSP 1" Male

Functional diagram

AE090JXYD*/AE120JXYD*/AE140JXYD*/AE160JXYD*

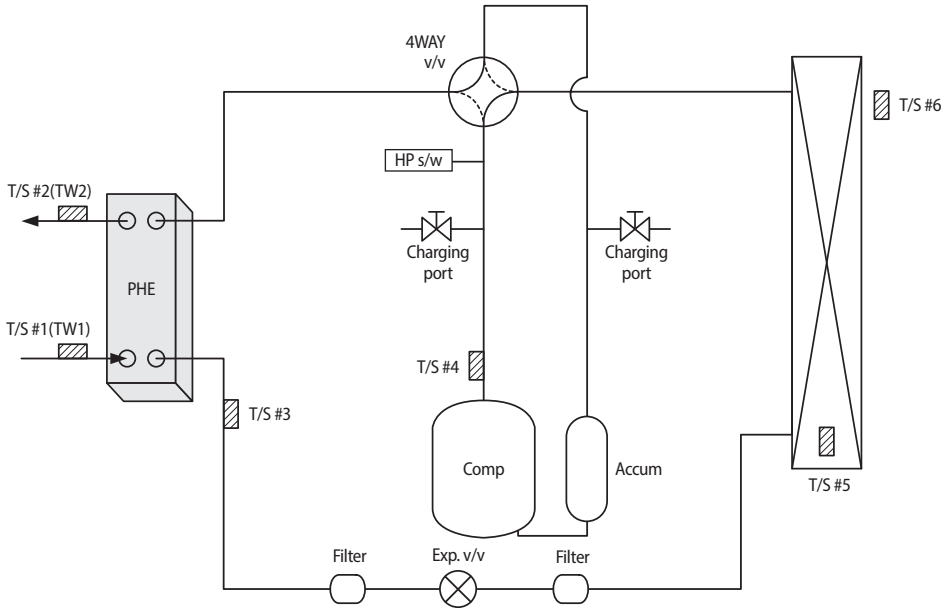

Part	Description
PHE	Plate heat exchanger
T/S #1	For water inlet temp sensor
T/S #2	For water outlet temp sensor
T/S #3	For PHE temp sensor
T/S #4	For discharge temp
T/S #5	For cond temp
T/S #6	For ambient temp sensor
Charging port	For refrigerants
Accum	Accumulator

Installing the unit

Moving the outdoor unit

- ▶ Select the moving route in advance.
- ▶ Be sure that moving route is safe from weight of the outdoor unit.
- ▶ Do not slant the product more than 30° when carrying it. (do not lay the product down sideways)
- ▶ The surface of the heat exchanger is sharp. Be careful not to be injured while moving and installing.

Moving the outdoor unit by wire rope

- ▶ Fasten the outdoor unit by two 8m or longer wire ropes as shown at the figure. To prevent from damage or scratches, insert a piece of cloth between the outdoor unit and rope, then move the unit.

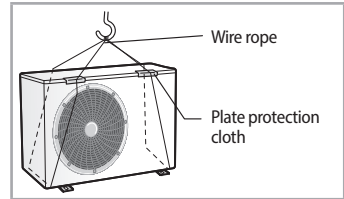

* The appearance of the unit may be different from the picture depending on the model.

Moving the outdoor unit with a fork lift

- ▶ Insert the fork into the wooden pallet at the bottom of the outdoor unit carefully. Be careful that the fork does not damage the outdoor unit.

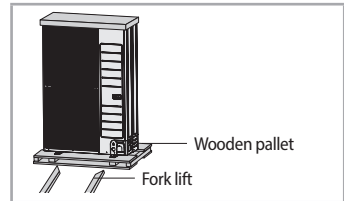

Installing the unit

Deciding on where to install the outdoor unit

Decide the installation location regarding the following condition and obtain the user's approval.

- ▶ The outdoor unit must not be placed on its side or upside down, as the compressor lubrication oil will run into the cooling circuit and seriously damage the unit.
- ▶ Choose a location that is dry and sunny, but not exposed to direct sunlight or strong winds.
- ▶ Do not block any passageways or thoroughfares.
- ▶ Choose a location where the noise of the Air to Water Heat Pump when running and the discharged air do not disturb any neighbours.
- ▶ Choose a position that enables the pipes and cables to be easily connected to the other hydraulic system.
- ▶ Install the outdoor unit on a flat, stable surface that can support its weight and does not generate any unnecessary noise and vibration.
- ▶ Position the outdoor unit so that the air flow directly stream towards the open area.
- ▶ Place the outdoor unit where there are no plants and animals because they may cause malfunction of outdoor unit.
- ▶ Maintain sufficient clearance around the outdoor unit, especially from a radio, computer, stereo system, etc.
- ▶ When installing the outdoor unit near seashore, make sure it is not directly exposed to sea breeze. If you can not find an adequate place without direct sea breeze, make sure to apply anti-corrosion coating on the heat exchanger.

- ▶ Install the outdoor unit in a place (such as near buildings etc.) where it can be prevented from sea breeze which can damage the outdoor unit.

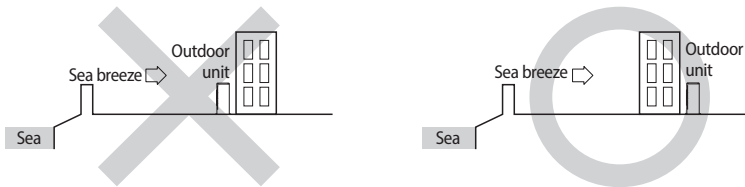

- ▶ If you cannot avoid installing the outdoor unit by the seashore, construct a protection wall around to block the sea breeze.

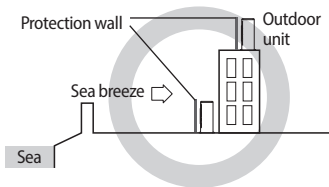

- Protection wall should be constructed with a solid material such as concrete to block the sea breeze and the height and the width of the wall should be 1.5 times larger than the size of the outdoor unit. Also, secure over 700mm between the protection wall and the outdoor unit for exhausted air to ventilate.

- ▶ Install the outdoor unit in a place where water can drain smoothly.

- * If you cannot find a place satisfying above conditions, please contact manufacturer. Make sure to clean the sea water and the dust on the outdoor unit heat exchanger and spread corrosion inhibitor on heat exchanger.(At least one time per one year.)



- Depending on the condition of power supply, unstable power or voltage may cause malfunction of the parts or control system. (At the ship or places using power supply from electric generator, etc).

- ▶ Do not install the Air to Water Heat Pump in following places.
 - The place where there is mineral oil or arsenic acid. There is a chance that parts may get damaged due to burned resin. The capacity of the heat exchanger may reduce or the Air to Water Heat pump may be out of order.
 - The place where corrosive gas such as sulfurous acid gas generates from the vent pipe or air outlet. The copper pipe or connection pipe may corrode and refrigerant may leak.
 - The place where there is a danger of existing combustible gas, carbon fiber or flammable dust. The place where thinner or gasoline is handled.



CAUTION

- This device must be installed according to the national electrical rules.
- With an outdoor unit having net weight upper than 60kg, we suggest do not install it suspended on wall, but considering floor standing one.

- ▶ If the outdoor unit is installed at a height, ensure that its base is firmly fixed in position.
- ▶ Make sure that the water dripping from the drain hose runs away correctly and safely.
- ▶ When you install the outdoor unit at wayside, you should install it above 2m height or make sure that the heat from the outdoor unit shouldn't be in direct contact with passersby. (The ground for application :The revision of regulation for facility in building by the law of the Ministry of Construction and Transportation.

Installing the unit

Space requirements for outdoor unit

When installing 1 outdoor unit

(Unit : mm)

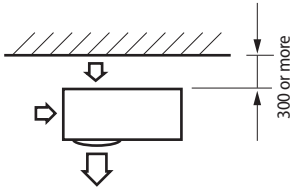

- * When the air outlet is opposite the wall

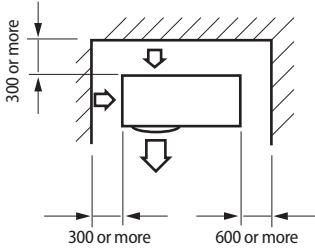

- * When 3 sides of the outdoor unit are blocked by the wall

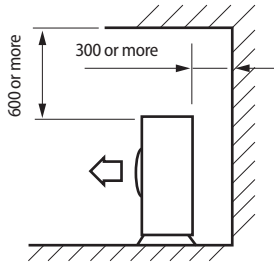

- * The upper part of the outdoor unit and the air outlet is opposite the wall

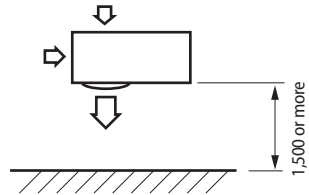

- * When the air outlet is towards the wall

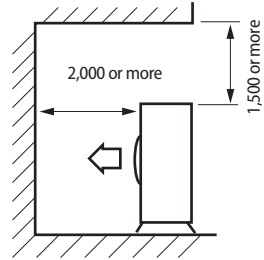

- * The upper part of the outdoor unit and the air outlet is towards the wall

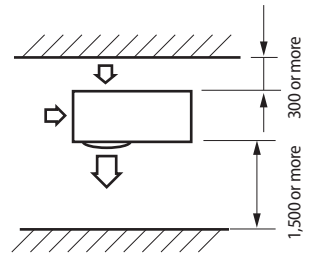

- * When front and rear side of the outdoor unit is towards the wall

When installing more than 1 outdoor unit

(Unit : mm)

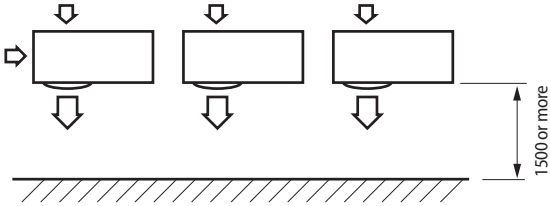

* When the air outlet is towards the wall

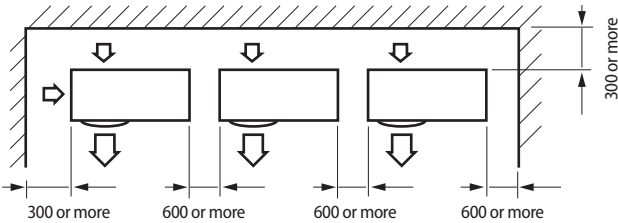

* When 3 sides of the outdoor unit are blocked by the wall

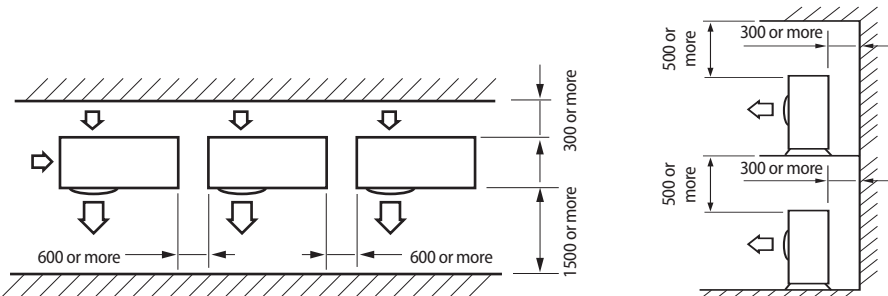

* When front and rear side of the outdoor unit is towards the wall

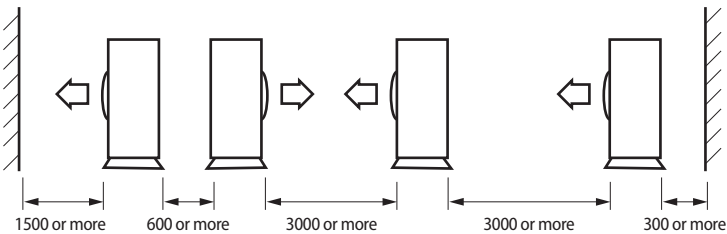

* The upper part of the outdoor unit and the air outlet is opposite the wall

* When front and rear side of the outdoor unit is towards the wall



! The units must be installed according to distances declared, in order to permit accessibility from each side, either to guarantee correct operation of maintenance or repairing products. The unit's parts must be reachable and removable completely under safety condition (for people or things).

Installing the unit

Outdoor unit installation

The outdoor unit must be installed on a rigid and stable base to avoid any increase in the noise level and vibration, particularly if the outdoor unit is to be installed in a location exposed to strong winds or at a height, the unit must be fixed to an appropriate support (wall or ground).

- ▶ Fix the outdoor unit with anchor bolts.



- The anchor bolt must be 20mm or higher from the base surface.



- When tightening the anchor bolt, tighten the rubber washer to prevent the outdoor unit bolt connection part from corroding.
- Make a drain outlet around the base for outdoor unit drainage.
- If the outdoor unit is installed on the roof, you have to check the ceiling strength and waterproof the unit.

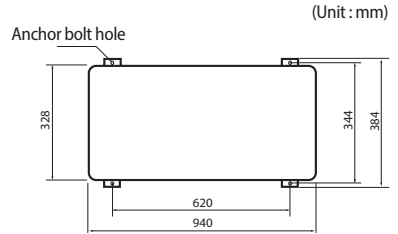

Outdoor unit support

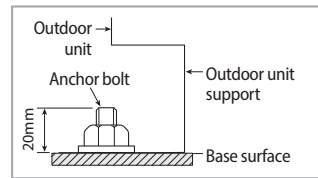
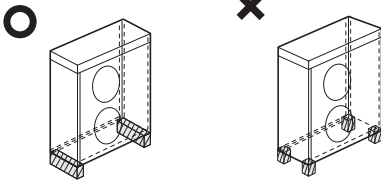

OUTDOOR UNIT INSTALLED ON THE WALL BY RACK

- ▶ Ensure the wall will be able to suspend the weight of rack and outdoor unit ;
- ▶ Install the rack close to the column as much as possible ;
- ▶ Install proper grommet in order to reduce noise and residual vibration transferred by outdoor unit towards wall.

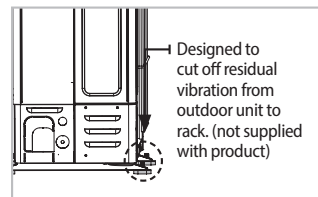

When installing air guide duct

- Check and make sure that screws do not damage the copper pipe.
- Secure air guide duct on guard fan.

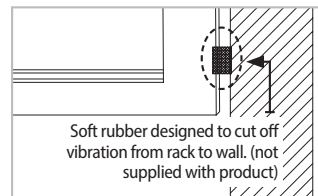

Drain work

• General area

While Air-Water Heat Pump is running in heating mode, Ice can begin accumulate on the surface of condenser. To prevent Ice from growing, system go into De-frost mode and then Ice on the surface changes to water.

Dropped water from condenser shall be eliminated through running drain holes to prevent Ice growing at low temperature.

- ▶ In case there is not enough space for drainage out of the unit, additional drain works are required. Follow the description as below
 - Make space more than 100mm between the bottom of the outdoor unit and the ground for installation of the drain hose.
 - Insert the drain plug into the hole on the bottom of the outdoor unit.
 - Connect the drain hose to the drain plug.
 - Make sure dusts or small branches should not go into the drain hose.

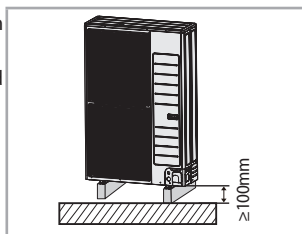

• If drain work is not enough, it can lead to system performance degradation and system damages.

Drain hole $\Phi 20 \times 4$ ea

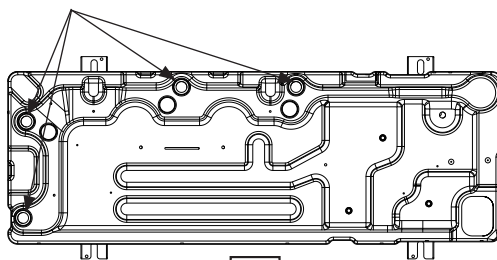

Air discharge side



Drain plug x 1ea



Drain cap x 3ea

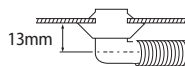

13mm

1. Prepare a water drainage channel around the foundation, to drain waste water from around the unit.
2. If the water drainage of the unit is not easy, please build up the unit on a foundation of concrete blocks, etc. (the height of the foundation should be maximum 150 mm).
3. If you install the unit on a frame, please install a waterproof plate within 150 mm of the underside of the unit in order to prevent the invasion of water from the lower direction.
4. When installing the unit in a place frequently exposed to snow, pay special attention to elevate the foundation as high as possible.
5. If you install the unit on a building frame, please install a waterproof plate (field supply) (within 150mm of the underside of the unit) in order to avoid the drain water dripping. (See figure)

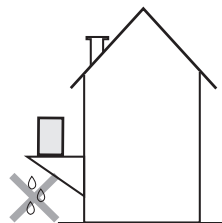

Installing the unit

• Heavy snow fall area (Natural drainage)

- ▶ When using the air conditioner in the heating mode, ice may accumulate. During de-icing (defrost operation), the condensed water must be drained off safely. For the air conditioner operates well, you must follow the instructions below.
 - Make space more than 80mm between the bottom of the outdoor unit and the ground for installation.

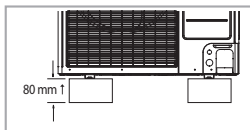

- If the product is installed in a region of heavy snow, allow enough separation distance between the product and the ground.
- When installing the product, make sure that the rack is not placed under the drain hole.
- Ensure that the drained water runs off correctly and safely.



- In areas with heavy snow fall, piled snow could block the air intake. To avoid this incident, install a frame that is higher than estimated snow fall. In addition, install a snow-proof hood to avoid snow from piling on the outdoor unit.
- If ice accumulates on the base, it may cause critical damage to the product. (e.g., a lakeside in a cold area, the seashore, an alpine region, etc.)
- In a heavy snowfall area, do not install the drain plug and drain cap into the outdoor unit. And, it may cause frozen ground. Therefore, take appropriate measures to prevent it.

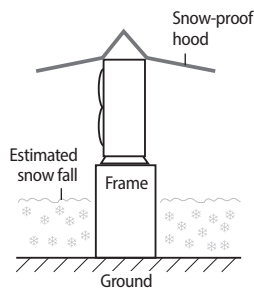

Selecting a location in cold climates



• When operating the unit in a low outdoor ambient temperature, be sure to follow the instructions described below.

- ▶ To prevent exposure to wind, install the unit with its suction side facing the wall.
- ▶ Never install the unit at a site where the suction side may be exposed directly to wind.
- ▶ To prevent exposure to wind, install a baffle plate on the air discharge side of the unit.
- ▶ In heavy snowfall areas it is very important to select an installation site where the snow will not affect the unit. If lateral snowfall is possible, make sure that the heat exchanger coil is not affected by the snow (If necessary construct a lateral canopy)

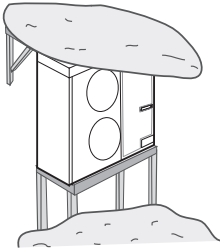

1. Construct a large canopy.
2. Construct a pedestal.
 - Install the unit high enough off the ground to prevent it being buried under snow.

- ▶ The outdoor unit should be installed with consideration of the direction of strong winds. These can make the unit turn over, so the side of the unit should be set to face the wind, not the front of the unit.

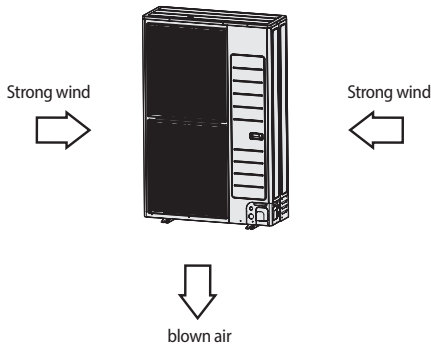

Piping work

Water connections must be made in accordance with the outlook diagram delivered with the unit, respecting the water in- and outlet. If air, moisture or dust gets in the water circuit, problems may occur. Therefore, always take into account the following when connecting the water circuit:

- ▶ Use clean pipes only.
- ▶ Hold the pipe end downwards when removing burrs.
- ▶ Cover the pipe end when inserting it through a wall so that no dust and dirt enter.
- ▶ Use a good thread sealant for the sealing of the connections.
The sealing must be able to withstand the pressures and temperatures of the system.
- ▶ When using non-brass metallic piping, make sure to insulate both materials from each other to prevent galvanic corrosion.
- ▶ Because brass is a soft material, use appropriate tooling for connecting the water circuit.
Inappropriate tooling will cause damage to the pipes.

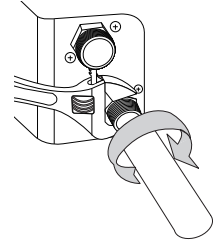

- Be careful not to deform the unit piping by using excessive force when connecting the piping. Deformation of the piping can cause the unit to malfunction.
- Always use two wrenches (spanners) for tightening or loosening the water connections, and tighten connections with a torque wrench as specified in below table. If not, connections and parts can be damaged and leaks.
- The unit is only to be used in a closed water system. If applications are in open water circuit, it will generate Heat exchangers fouling, Corrosion, Leak.

	Name	Tightening torque	
1	BSPP1	350~380 kgf·cm	34 ~ 37 N·m
2	Flow switch	72~82 kgf·cm	7 ~ 8 N·m

Flushing and air-purging

When filling water, the following start-up procedure should be followed.

1. All system components and pipes must be tested for the presence of leaks.
2. Preparation of a make-up water assembly or flushing unit is recommended for installation and service.
3. Before connecting pipes to the Outdoor Unit, flush water pipes clean to remove contaminants during hours using a flushing unit or tap water pressure if it is adequate (at 2 to 3 bar)
4. Fill water into the Outdoor Unit by opening shut-off & drain valve.
5. Purge the air. (Fill with a flushing unit with sufficient capacity: avoid aerating the water)
6. Circulate for long enough to ensure that all air has been bled from the complete water piping system.



- After installations, commissioning should be performed by qualified representatives. Unless flushing and air-purging works are performed adequately, it might result in malfunctions.



Flushing unit
(or purging cart)



CAUTION

• **Before installing/commissioning the unit, make sure to check the following points :**

- The maximum water pressure of the unit is 2.8 bar static pressure.
- The operating range of leaving water temperature is 25~55°C at heating conditions and 5~25°C at cooling conditions.
- The minimum required water flow for operation is 16 liters/min. At all times the required water flow-rates should remain. Otherwise, the unit can stop due to a lack of water.
- Water quality must be according to EN directive 98/83 EC.
- If the unit and the pipes are exposed to freezing temperature, It can cause damage to the hydraulic system. Special care must be taken to prevent freezing of the total water system.
- The unit is designed to be used in a closed-loop system. Do not use any other components which are designed only for an open-loop system.
- Never use Zn-coated parts in the water circuit.
- All hydraulic parts including field piping must be insulated to reduce heat loss and condensation.
- It is recommended to install the make-up water assembly to feed small quantities of water to the system automatically, replacing the minor water losses and maintaining the system pressure.
- Drain taps must be provided at all low points of the system to permit complete drainage of the circuit for maintenance use.
- Make sure that the check valves are correctly installed in the system (field supply).
- Flush pipes out with clean water to remove contaminants in pipes during installation.
- The strainer(water filter) must be cleaned after flushing the pipes, and it should be cleaned periodically. Replace strainer when necessary.
- Charging : Charge the water until a pressure of 1.5~2.0bar by using make-up water assembly(Field supply). (The water pressure indicated on the manometer will vary depending on the water temperature)
The nominal water pressure in the system should remain about 1.0 bar at all times to avoid air entering the water system.
- Air purging; Make sure that air should be vented from the system at start-up or after installing/ servicing. The air vent valve must be opened during charging the water (at least 2 turns) in order to remove all air in the circuit, and a make-up water assembly allows water into the system continuously.
- In case that the water piping would be located in a higher position than the air vent of the unit, it is necessary to add an additional one in the highest position of water circuit. The air vent should be located both where water temperatures are the highest and where the height of pipes are the highest.
- Always use materials which are compatible with water used in the system and with the materials used on the indoor unit.
- Select piping diameter in relation to required water flow and available ESP of the pump.
- Use chemical cleaning agents(Begin with acid , finish with alkali).
- Do not operate the system with closed valves because it results in damaging the heat pump.

Piping work

Freeze protection

Freeze protection solutions must use propylene glycol with a toxicity rating of Class 1 as listed in Clinical Toxicology of Commercial Products, 5th Edition.



- Ethylene glycol is toxic and must not be used in the primary water circuit in case of any cross-contamination of the potable circuit.

Freezing Points of Propylene Glycol - Water Mixtures		
Percent Propylene Glycol [wt. %]	Freezing Point [°F]	Freezing Point [°C]
0	32	0
10	26	-3
20	20	-7
30	10	-12
36	0	-18
40	-5	-20
43	-10	-23
48	-20	-29

Setting capacity and pre-pressure of the expansion vessel

When it is required to change the default pre-pressure of the expansion vessel(1 bar), keep in mind the following guidelines:

- Use only dry nitrogen to set the expansion vessel pre-pressure.
- Inappropriate setting of the expansion vessel pre-pressure will lead to malfunction of the system. Therefore, the pre-pressure should only be adjusted by a licensed installer.

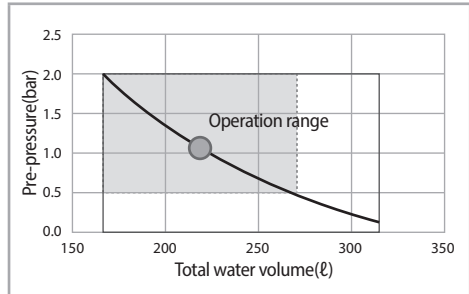

Installation height difference(a)	Water volume	
	< 220 Litres	> 220 Litres
<7m	No pre-pressure adjustment required.	Actions required: <ul style="list-style-type: none"> Pre-pressure must be decreased, calculate according to "Calculating the pre-pressure of the expansion vessel". Check if the water volume is lower than maximum allowed water volume.
>7m	Actions required: <ul style="list-style-type: none"> Pre-pressure must be increased, calculate the appropriate value following by "Calculating the pre-pressure of the expansion vessel". Check if the water volume is lower than maximum allowed water volume. 	Expansion vessel of the unit too small for the installation.

(a) Installation height difference: height difference(m) between the highest point of the water circuit and the indoor unit. If the unit is located at the highest point of the installation, the installation height is considered 0m.

- When Expansion vessel has a capacity 8 liters and 1 bar pre-charged. Water volume of total system for reliable performance is minimum 50liters.

Calculating the pre-pressure of the expansion vessel

- ▶ The pre-pressure(P_g) to be set depends on the maximum installation height difference(H) and is calculated as below :
 $P_g = (H/10 + 0.3)$ bar

Unit resistance and PHE resistance by glycol concentrate

The unit is composed of water pipes and PHE basically.

To ensure correct operation and predict the expected performance, Flow and Resistance table can be used and Flow and Resistance characteristic is dependent on Glycol concentration.

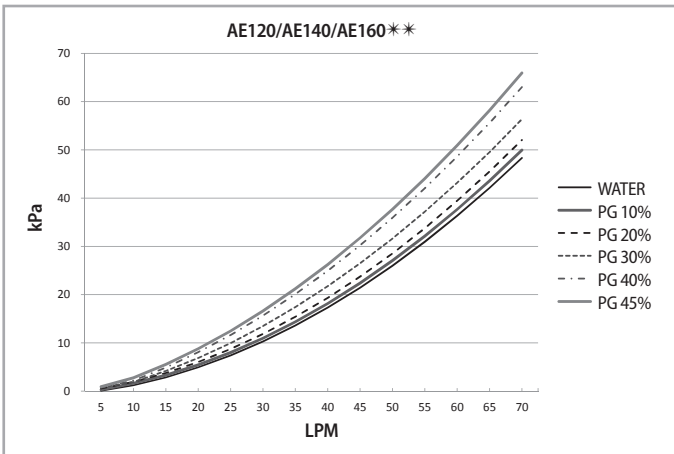
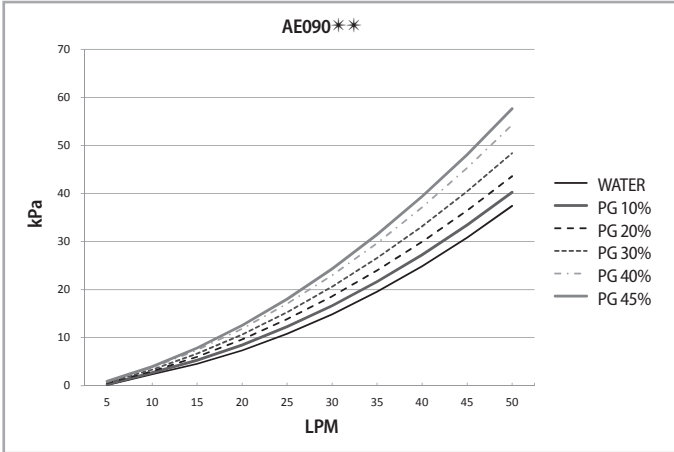

Changing Glycol concentration can cause the pressure drop of the system and it can lead to make flow rate rather slow. Just in case performance degrades, installer shall be careful of flow rate changes.

Piping work

Flow switch

Flow switch is not integrated part in MONO Unit. But the installation is essential to operate MONO Unit.

Flow switch is provided by Samsung control kit as a sub component.



- Flow switch shall be installed described by installation manual of Mono unit or Control kit.
- All electric wiring works shall be implemented by manuals which Samsung provided.
- Before completing the installation works, make sure to check if the flow switch is installed in horizontal and if flow direction is in parallel with pipe direction. (Straight length of In and Out pipe of flow switch shall have 5 times length in diameter)

Charging water

After installation is completed, the following procedures shall be used to charge water into the Outdoor Unit.

- ▶ Connect water lines to water connections of Air-Water Heat Pump.
- ▶ Air vent valve shall be open at least 2turns so that air can be eliminated in the system.
- ▶ Open the shut-off & drain valve in the water supply connection.
- ▶ Water pressure of supply line shall be over 2.0 bar for good charging work.
- ▶ Stop water supply when the pressure indicates around 2.0 bar.

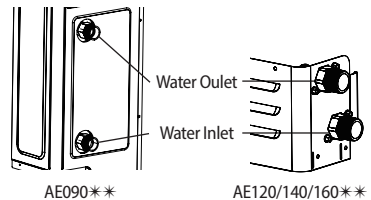

- There shall be enough space for Service works.
- Water pipe and connections shall be cleaned by using water or cleaner before operating the unit at first time.
- Considering E.S.P and water pump performance, select water plumbing specification and under floor loofs.
- Make sure to calculate the total resistance of piping system and determine the size of pipes before selecting the required head of pumps. If the pressure loss of total water system is over than designed pressure, an external water pump shall be installed on piping system in series.
- Do not connect power supply while water is charging.
- When initial installation or re-installation is required, remove air by air vent valve in water plumbings which are installed by local installers to prevent air trap in the system while charging water.
- Make sure that back flow preventer (check valves) shall be installed on main supply line to prevent from contaminating the city water.
 - It is recommended to install the make-up water assembly to prevent from contaminating the city water.
 - Check valves in the make-up water assembly can prevent running water inside Outdoor Unit from contaminating water supplies during installation or maintenance works.

Pressure relief valve

MONO Unit does not have a pressure relief valve. The valve shall prevents abnomal water pressure from damaging the the system by opening at 3.0 bar.



- Make certain that the discharged water out of drain pan does not affect other elements.

Filter / Strainer

Installation of Filter / Strainer is mandatory for water system. The Filter or Strainer shall be located in front of inlet pipe of PHE.

While operating the system, some dust and foreign materials can circulate the system and can make the whole system not work well due to blockage of heat exchangers and corrosion in some components.

Filter mesh : #50

Piping insulation

The complete water circuit, inclusive all piping, must be insulated to prevent condensation during cooling operation and reduction of the heating and cooling capacity as well as prevention of freezing of the outside water piping during winter time. The thickness of the sealing materials must be at least 9 mm with (0.035 W/mK) in order to prevent freezing on the outside water piping.

If the temperature is higher than 30°C and the humidity is higher than RH 80%, then the thickness of the sealing materials should be at least 20 mm in order to avoid condensation on the surface of the sealing.

Wiring

Two electronic cables must be connected to the outdoor unit.

- ▶ The connection cord between indoor unit and outdoor unit.
- ▶ The power cable between outdoor unit and auxiliary circuit breaker.
- ▶ Specially for Russian and European market, before installation, the supply authority should be consulted to determine the supply system impedance to ensure compliance.



- During the unit installation make first refrigerant connections and then electrical connections. If unit is uninstalled first disconnect electrical cables, then refrigerant connections.
- Connect the Air to water heat pump to grounding system before performing the electrical connection.
- When installing the unit, you shouldn't use inter connection wire.

Example of EHS system

When using ELB/ELCB for 1 phase (220-240V~)

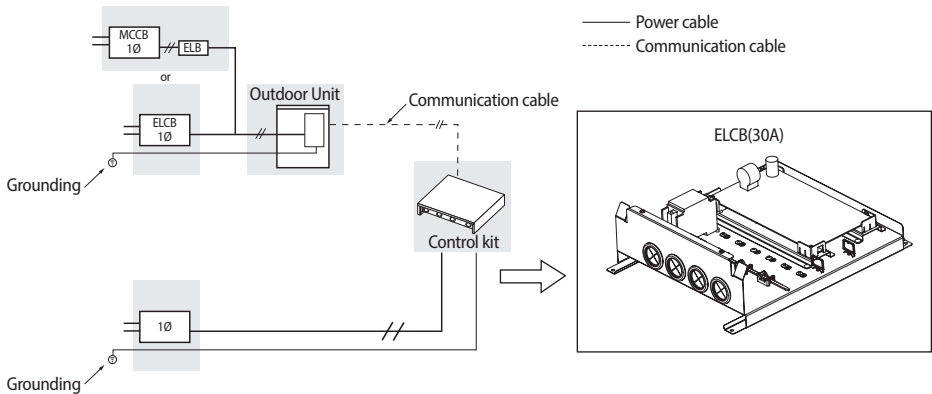

When using ELB/ELCB for 3 phase 4 wires (380-415V~)

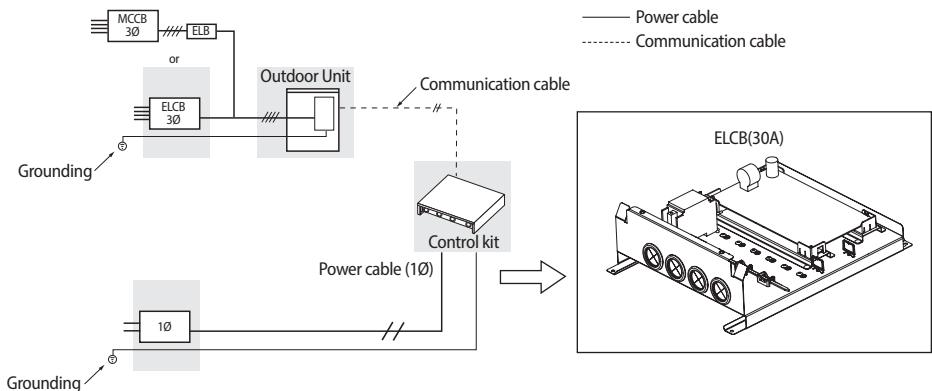

- * If an outdoor unit is installed in a place in danger of an electric leak or submergence, you must install the ELB/ELCB.
- * Installation of control kit must be followed its Installation manual.

Power Cable Specifications

1 phase

Outdoor unit	Rated		Voltage Range		MCA	MFA
	Hz	Volts	Min	Max	Min. Circuit Amps.	Max. Fuse Amps.
AE090JXYDEH	50	220-240	198	264	22 A	27.5 A
AE120JXYDEH	50	220-240	198	264	28 A	35 A
AE140JXYDEH	50	220-240	198	264	30 A	37.5 A
AE160JXYDEH	50	220-240	198	264	32 A	40 A

- ▶ The power cable is not supplied with Air to water heat pump.
- ▶ Supply cords of parts of appliances for outdoor use shall not be lighter than polychloroprene sheathed flexible cord (Code designation IEC:60245 IEC 57 / CENELEC:H05RN-F)
- ▶ This Equipment complies with IEC 61000-3-12.

Indoor Unit	Load	Power supply	Power cable	MAX. length	Type GL 
			mm ² ,wires	m	A
MIM-E03AN	No Heater (Water Pump, Valve, Wired RMC)	1Ø, 220-240V, 50Hz	1.5 / 3	<10m	10
			2.5 / 3	10m<L<20m	10
	Booster Heater (3kw)		4.0 / 3	<10m	20
			6.0 / 3	10m<L<20m	20
	Booster Heater (~3kw) + Backup Heater (~3kw)		6.0 / 3	<10m	40
			8.0 / 3	10m<L<20m	40

- ▶ The Power cable is not supplied with the heat pump.
- ▶ For power cable, use the grade H05RN-F materials in 1Ø system.
- ▶ If you connect Backup Heater at separated power cable, you can reduce wire size. (Please refer to control kit installation manual)

3 Phase

Outdoor unit	Rated		Voltage Range		MCA	MFA
	Hz	Volts	Min	Max	Min. Circuit Amps.	Max. Fuse Amps.
AE090JXYDGH	50	380-415	342	457	10 A	16.1 A
AE120JXYDGH	50	380-415	342	457	10 A	16.1 A
AE140JXYDGH	50	380-415	342	457	12 A	16.1 A
AE160JXYDGH	50	380-415	342	457	12 A	16.1 A

- ▶ The power cable is not supplied with air to water heat pump.
- ▶ Supply cords of parts of appliances for outdoor use shall not be lighter than polychloroprene sheathed flexible cord (Code designation IEC:60245 IEC 66 / CENELEC:H07RN-F)
- ▶ This equipment complies with IEC 61000-3-12 provided that the short-circuit power S_{sc} is greater than or equal to $3.3[MVA]$ at the interface point between the user's supply and the public system. It is the responsibility of the installer or user of the equipment to ensure, by consultation with distribution network operator if necessary, that the equipment is connected only to a supply with a short-circuit power S_{sc} greater than or equal to $3.3[MVA]$.

Wiring

Between indoor unit and outdoor unit connection cable specifications(Common in use)

Communication cable	Home server
0.75mm ² , 2wires	0.75mm ² , 2wires

- ▶ For the power Cable, use the grade H07RN-F or H05RN-F materials.

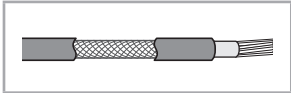

When installing the control kit in a computer room or network room, use the double shielded (Tape aluminum / polyester braid + copper) cable of FROHH2R type.

1-phase terminal block spec

AC power : M5 screw

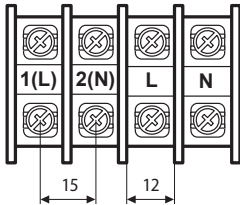

Communication : M4 screw

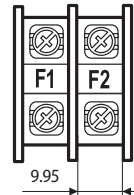

3-phase terminal block spec

AC power : M4 screw

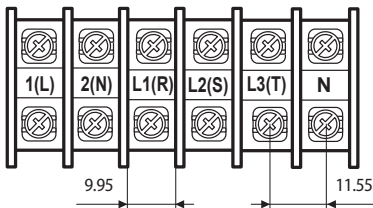

Communication : M4 screw

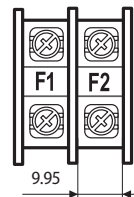

Wiring diagram of power cable

When using ELB for 1 phase and 3 phase

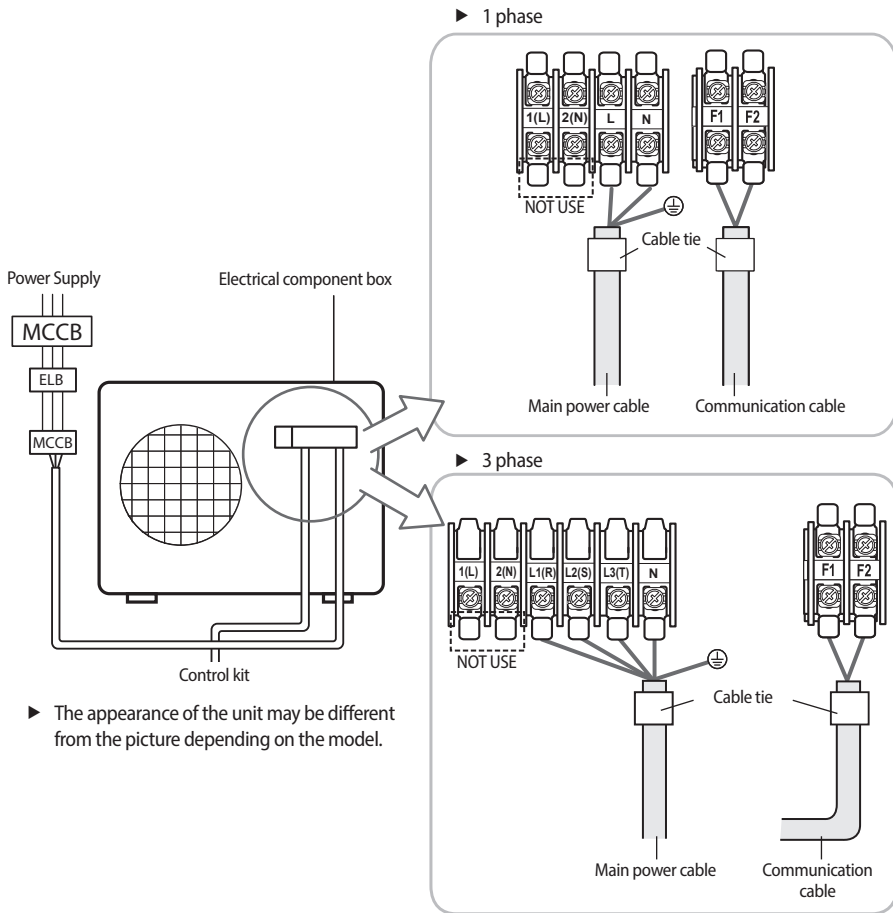

- You should connect the power cable into the power cable terminal and fasten it with a clamp.
- The unbalanced power must be maintained within 2% of supply rating.
 - If the power is unbalanced greatly, it may shorten the life of the condenser. If the unbalanced power is exceeded over 4% of supply rating, the control kit is protected, stopped and the error mode indicates.
- To protect the product from water and possible shock, you should keep the power cable and the connection cord of the control kit and outdoor units within ducts. (with appropriate IP rating and material selection for your application)
- Ensure that main supply connection is made through a switch that disconnects all poles, with contact gap of at least 3 mm.
- Devices disconnected from the power supply should be completely disconnected in the condition of overvoltage category.
- Keep distances of 50mm or more between power cable and communication cable.

Wiring

Wiring diagram of connection cord

1 phase

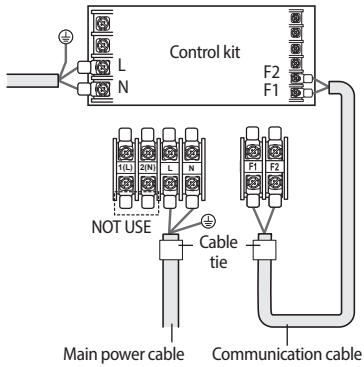

3 phase

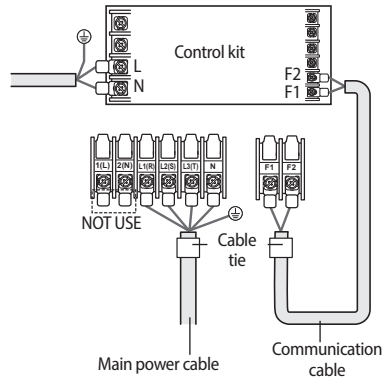

NOTE



- Lay the electrical wiring so that the front cover does not rise up when doing wiring work and attach the front cover securely.
- Ground wire for the indoor unit and outdoor unit connection cable must be clamped to a soft copper tin-plated eyelet terminal with screw hole (NOT SUPPLIED WITH UNIT ACCESSORIES).

Connecting the power terminal

- ▶ Connect the cables to the terminal board using the compressed ring terminal.
- ▶ Cover a solderless ring terminal and a connector part of the power cable and then connect it.

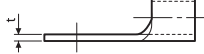
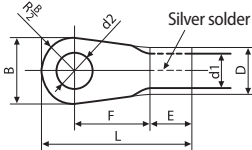

Nominal dimensions for cable [mm ² (inch)]		4/6 (0.006/0.009)		10 (0.01)	16 (0.02)	25 (0.03)		35 (0.05)		50 (0.07)	70 (0.10)
Nominal dimensions for screw [mm(inch)]		4 (3/8)	8 (3/16)	8 (3/16)	8 (3/16)	8 (3/16)		8 (3/16)		8 (3/16)	8 (3/16)
B	Standard dimension [mm(inch)]	9.5 (3/8)	15 (9/16)	15 (9/16)	16 (10/16)	12 (1/2)	16.5 (10/16)	16 (10/16)	22 (7/8)	22 (7/8)	24 (1)
	Allowance [mm(inch)]	±0.2 (±0.007)		±0.2 (±0.007)	±0.2 (±0.007)	±0.3 (±0.011)		±0.3 (±0.011)		±0.3 (±0.011)	±0.4 (±0.011)
D	Standard dimension [mm(inch)]	5.6 (1/4)		7.1 (1/4)	9 (3/8)	11.5 (7/16)		13.3 (1/2)		13.5 (1/2)	17.5 (11/16)
	Allowance [mm(inch)]	+0.3 (+0.011) -0.2 (-0.007)		+0.3 (+0.011) -0.2 (-0.007)	+0.3 (+0.011) -0.2 (-0.007)	+0.5 (+0.019) -0.2 (-0.007)		+0.5 (+0.019) -0.2 (-0.007)		+0.5 (+0.019) -0.2 (-0.007)	+0.5 (+0.019) -0.4 (-0.015)
d1	Standard dimension [mm(inch)]	3.4 (1/8)		4.5 (3/16)	5.8 (1/4)	7.7 (5/16)		9.4 (3/8)		11.4 (7/16)	13.3 (1/2)
	Allowance [mm(inch)]	±0.2 (±0.007)		±0.2 (±0.007)	±0.2 (±0.007)	±0.2 (±0.007)		±0.2 (±0.007)		+0.3 (+0.011) -0.2 (-0.007)	±0.4 (±0.015)
E	Min. [mm(inch)]	6 (1/4)		7.9 (5/16)	9.5 (5/16)	11 (3/8)		12.5 (1/2)		17.5 (11/16)	18.5 (3/4)
F	Min. [mm(inch)]	5 (3/16)	9 (3/8)	9 (3/8)	13 (1/2)	15 (5/8)	13 (1/2)	13 (1/2)		14 (9/16)	20 (3/4)
L	Max. [mm(inch)]	20 (3/4)	28.5 (1-1/8)	30 (1-3/16)	33 (1-5/16)	34 (1-3/8)		38 (1-1/2)	43 (1-11/16)	50 (2)	51 (2)
d2	Standard dimension [mm(inch)]	4.3 (3/16)	8.4 (1-3/16)	8.4 (1-3/16)	8.4 (1-3/16)	8.4 (1-3/16)		8.4 (1-3/16)		8.4 (1-3/16)	8.4 (1-3/16)
	Allowance [mm(inch)]	+0.2 (+0.007) 0(0)	+0.4 (+0.015) 0(0)	+0.4 (+0.015) 0(0)	+0.4 (+0.015) 0(0)	+0.4 (+0.015) 0(0)		+0.4 (+0.015) 0(0)		+0.4 (+0.015) 0(0)	+0.4 (+0.015) 0(0)
t	Min. [mm(inch)]	0.9 (0.03)		1.15 (0.04)	1.45 (0.05)	1.7 (0.06)		1.8 (0.07)		1.8 (0.07)	2.0 (0.078)

- ▶ Connect the rated cables only.
- ▶ Connect using a driver which is able to apply the rated torque to the screws.
- ▶ If the terminal is loose, fire may occur caused by arc. If the terminal is connected too firmly, the terminal may be damaged.

Tightening Torque (kgf • cm)		
M4	12~18	Communication : F1, F2
		3phase AC power : L1(R), L2(S), L3(T), N
M5	20~30	1phase AC power : L, N







CAUTION

- When connecting cables, you can connect the cables to the electrical part or connect them through the holes below depending on the spot.
- Run transmission wiring between the indoor and outdoor units through a conduit to protect against external forces, and feed the conduit through the wall together with refrigerant piping.
- Remove all burrs at the edge of the knock-out hole and secure the cable to the outdoor knock-out using lining and bushing with an electrical insulation such as rubber and so on.
- Must keep the cable in a protection tube.
- Keep distances of 50mm or more between power cable and communication cable.
- When the cables are connected through the hole, remove the Plate bottom.

Wiring

How to connect your extended power cables

1. Prepare the following tools.

Tools	Crimping pliers	Connection sleeve (mm)	Insulation tape	Contraction tube (mm)
Spec	MH-14	20xØ6.5(HxOD)	Width 19mm	70xØ8.0(LxOD)
Shape				

2. As shown in the figure, peel off the shields from the rubber and wire of the power cable.
 - Peel off 20 mm of cable shields from the pre-installed tube.

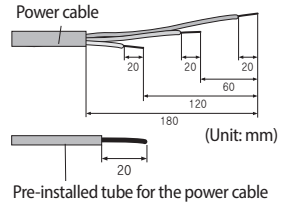

- For information about the power cable specifications for indoor and outdoor units, refer to the installation manual.
- After peeling off cable wires from the pre-installed tube, insert a contraction tube.

3. Insert both sides of core wire of the power cable into the connection sleeve.

► Method 1

Push the core wire into the sleeve from both sides.

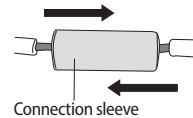

► Method 2

Twist the wire cores together and push it into the sleeve.

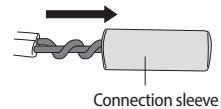

4. Using a crimping tool, compress the two points and flip it over and compress another two points in the same location.
 - The compression dimension should be 8.0.
 - After compressing it, pull both sides of the wire to make sure it is firmly pressed.

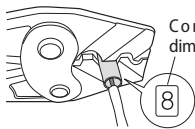

► Method 1

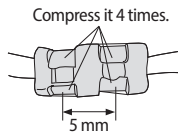

► Method 2

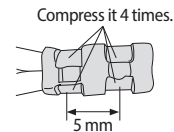

5. Wrap it with the insulation tape twice or more and position your contraction tube in the middle of the insulation tape. Three or more layers of insulation are required.

► **Method 1**

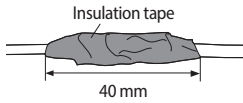

► **Method 2**

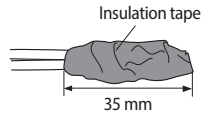

6. Apply heat to the contraction tube to contract it.

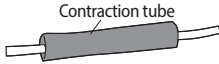

7. After tube contraction work is completed, wrap it with the insulation tape to finish.



- Make sure that the connection parts are not exposed to outside.
- Be sure to use insulation tape and a contraction tube made of approved reinforced insulating materials that have the same level of withstand voltage with the power cable. (Comply with the local regulations on extensions.)

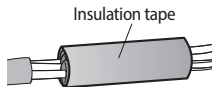

- In case of extending the electric wire, please **DO NOT** use a round-shaped Pressing socket.
- Incomplete wire connections can cause electric shock or a fire.

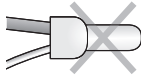

Testing operations

1. Check the power supply between the outdoor unit and the auxiliary circuit breaker.
 - 1 phase power supply : L, N
 - 3 phases power supply : R,S,T,N
2. Check the CONTROL KIT
 - 1) Check that you have connected the power and communication cables correctly. (If the power cable and communication cables one mixed up or connected incorrectly, the PCB will be damaged.)
 - 2) Check the temp. sensor, drain pump/hose, and display are connected correctly.
3. Press K1 or K2 on the outdoor unit PCB to run the test mode and stop.

KEY	KEY operation	7-segment display
K1	Press once : Heating test run	"1" "2" "BLANK" "BLANK"
	Press twice : Defrost test run	"1" "3" "BLANK" "BLANK"
	Press 3times : Finishing test mode	-
K2	Press once : Cooling test run (Heating Only : skip)	"1" "2" "BLANK" "BLANK"
	Press twice : Output signal test run	"1" "4" "BLANK" "BLANK"
	Press 3 times : Finishing test mode	-
K3	Reset	-
K4	View mode	Refer to View mode display

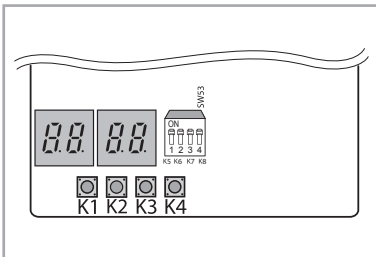
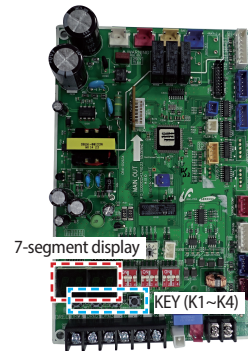

4. View Mode : When the K4 switch is pressed, you can see information about our system state as below.

Number of press	Display contents	Display				Units
		Segment 1	Segment 2	Segment 3	Segment 4	
0	Communication State	10s digit of Tx	1s digit of Tx	10s digit of Rx	1s digit of Rx	-
1	Order frequency	1	100s digit	10s digit	1s digit	Hz
2	Current frequency	2	100s digit	10s digit	1s digit	Hz
3	Pump output	3	100s digit	10s digit	1s digit	%
4	Outdoor air sensor	4	+/-	10s digit	1s digit	°C
5	Discharge sensor	5	100s digit	10s digit	1s digit	°C
6	Eva in sensor	6	+/-	10s digit	1s digit	°C
7	Inlet water sensor	7	+/-	10s digit	1s digit	°C
8	Outlet water sensor	8	+/-	10s digit	1s digit	°C
9	Cond sensor	9	+/-	10s digit	1s digit	°C
10	Current	A	10s digit	1s digit	First decimal	A
11	Fan RPM	B	1000s digit	100s digit	10s digit	rpm

Number of press	Display contents	Display				Units
		Segment 1	Segment 2	Segment 3	Segment 4	
12	Target discharge temperature	C	100s digit	10s digit	1s digit	°C
13	EEV	D	1000s digit	100s digit	10s digit	step
14	Protective control	E	0 : Cooling 1 : Heating	Protective control 0 : No protective control 1 : Freezing 2 : Defrosting 3 : Over-load 4 : Discharge 5 : Total current	Frequency status 0 : Normal 1 : Hold 2 : Down 3 : Up_limit 4 : Down_limit	-
15	IPM temp.	F	+/-	10s digit	1s digit	°C
long-1	Main Micom version	Year(Dec)	Month(Hex)	Day(two digit)	Day(One digit)	-
long-1 and 1	Inverter Micom version	Year(Hex)	Month(Hex)	Day(two digit)	Day(One digit)	-
long-1 and 2	EEPROM version	Year(Hex)	Month(Hex)	Day(two digit)	Day(One digit)	-

5. DIP Switching setting

KEY	ON (default)	OFF	Remark
K5	Heat Pump	Heating Only	
K6	Anti-stack snow mode OFF	Anti-stack snow mode ON	
K7	Silence operation		
K8	K7	K8	Mode
	ON	ON	Silence mode Step 1
	ON	OFF	Silence mode Step 2
	OFF	ON	Silence mode Step 3
	OFF	OFF	Silence mode Step 1
			In silence mode, no guarantee of capacity



WARNING

- Incorrect handling of thermostat, safety valve or other valves may lead to tank rupture. When servicing the unit follow instructions carefully:
 - Always turn off main power supply when water supply is being shut off.
 - Test the free operation of the safety valve regularly by opening the valve ensuring the water flows freely.
 - Electrical connection and all servicing of the electrical components should only be carried out by an authorized electrician.
 - Fitting and all servicing of plumbing fixtures should only be carried out by an authorized installer.
 - When replacing the thermostat, safety valve or any other valve or part supplied with this unit, use only approved parts of the same specification.

Error codes

If the unit has some problems and does not work normally, error code is shown on the OUTDOOR UNIT main PBA or LCD of the wired remote controller.

Display	Explanation	Error Source
101	CONTROL KIT / OUTDOOR UNIT wire connection error	CONTROL KIT, OUTDOOR UNIT
162	EEPROM Error	CONTROL KIT
198	Error of Terminal Block's Thermal Fuse(Open)	CONTROL KIT
201	CONTROL KIT/OUTDOOR UNIT communication error (Matching error)	CONTROL KIT, OUTDOOR UNIT
202	CONTROL KIT/OUTDOOR UNIT communication error (3 min)	CONTROL KIT, OUTDOOR UNIT
203	Communication error between INVERTER and MAIN MICOM (6 min)	OUTDOOR UNIT
221	OUTDOOR UNIT temperature sensor error	OUTDOOR UNIT
231	Condenser temperature sensor error	OUTDOOR UNIT
251	Discharge temperature sensor error	OUTDOOR UNIT
320	OLP sensor error	OUTDOOR UNIT
403	Detection of OUTDOOR UNIT compressor freezing (During cooling operation)	OUTDOOR UNIT
404	Protection of OUTDOOR UNIT when it is overload (during Safety Start, Normal operation state)	OUTDOOR UNIT
407	Comp down due to high pressure	OUTDOOR UNIT
416	Discharge of a compressor is overheated	OUTDOOR UNIT
425	Power source line missing error (only for 3-phase model)	OUTDOOR UNIT
440	Heating operation blocked (outdoor temperature over 35°C)	OUTDOOR UNIT
441	Cooling operation blocked (outdoor temperature under 9°C)	OUTDOOR UNIT
458	OUTDOOR UNIT fan1 error	OUTDOOR UNIT
461	[Inverter] Compressor startup error	OUTDOOR UNIT
462	[Inverter] Total current error/PFC over current error	OUTDOOR UNIT
463	OLP is overheated	OUTDOOR UNIT
464	[Inverter] IPM over current error	OUTDOOR UNIT
465	Compressor V limit error	OUTDOOR UNIT
466	DC LINK over/low voltage error	OUTDOOR UNIT
467	[Inverter] Compressor rotation error	OUTDOOR UNIT
468	[Inverter] Current sensor error	OUTDOOR UNIT
469	[Inverter] DC LINK voltage sensor error	OUTDOOR UNIT
470	Outdoor unit EEPROM Read/Write Error	OUTDOOR UNIT
471	Outdoor unit EEPROM Read/Write Error(OTP error)	OUTDOOR UNIT
474	IPM(IGBT Module) or PFCM temperature sensor Error	OUTDOOR UNIT

Display	Explanation	Error Source
475	OUTDOOR UNIT fan2 error	OUTDOOR UNIT
484	PFC Overload Error	OUTDOOR UNIT
485	Input current sensor error	OUTDOOR UNIT
500	IPM is overheated	OUTDOOR UNIT
554	Gas leak error	OUTDOOR UNIT
601	Communication error between the CONTROL KIT and wired remote controller	Wired Remote Controller
602	Wired remote controller Master/Slave setting error	Wired Remote Controller
604	Communication tracking error between the CONTROL KIT and wired remote controller	CONTROL KIT, Wired Remote Controller
607	Communication error between the Master and Slave wired remote controllers	Wired Remote Controller
901	Water inlet (PHE) temperature sensor error(open/short)	OUTDOOR UNIT
902	Water outlet (PHE) temperature sensor error(open/short)	OUTDOOR UNIT
903	Water outlet (backup heater) temperature sensor error.	CONTROL KIT
904	DHW tank temperature sensor error	CONTROL KIT
906	Refrigerant gas inlet (PHE) temperature sensor (open/short)	OUTDOOR UNIT
911	Flow switch and water pump error (F/S signal is OFF for 10 sec. during the water pump signal is ON)	CONTROL KIT
912	Flow switch and water pump error (Water pump signal is OFF for 60sec during the F/S signal is ON)	CONTROL KIT
916	Mixing valve sensor error	CONTROL KIT

Maintenance

Listed checks and inspections shall be implemented regularly so that the unit can operate as design intention in production site.

Always switch off the unit and remove power cable from the electric source before carrying out any maintenance or repair works.

Mentioned actions shall be carried out at least once a year by qualified personnel.

1. Water pressure
 - Check if the water pressure is above 0.3 bar. If necessary, fill a supplement water.
2. Water filter
 - Use water filter which is available for cleaning and clean it regularly.
3. Water pressure relief valve
 - Check for correct operation of the pressure relief valve.
 - The valve will work over the designated pressure.
 - If there is leakage of water or water splashed in normal condition, please contact your local installer.
4. Glycol
 - Record and check the glycol concentration and the pH-value in the system at least once a year.
 - A Ph-value below 8.0 indicates that a significant portion of the inhibitor has been depleted and that more inhibitor needs to be added.
 - When the Ph-value is below 7.0 then oxidation of the glycol occurred, the system should be drained and flushed thoroughly before severe damage occurs.
 - Make sure that the disposal of the glycol solution is done in accordance with relevant local and national regulation.

Adding refrigerant

The Heat Pump unit is provided to users with basic amounts of refrigerants as initial setting values. While using the unit or doing refrigerant piping works, there can be some loss of refrigerants compared to initial amounts. To run the units properly, keep the amount of refrigerant which SAMSUNG designated.

Procedures as below is describing how to adding the amount of refrigerant.

-  **WARNING**
- R-410A Shall be added as liquid phase.
 - Adding and recharging works shall be by Charging Ports.

1. Connect the manifold gauge and purge the manifold gauge.
2. Open the manifold gauge valve of the liquid side Charging Ports and add the liquid refrigerant.
3. If you cannot fully recharge the additional refrigerant while the outdoor unit is stopped, use the key on PCB in the Heat Pump to run for recharging the remaining refrigerant.

Adding refrigerants in running condition

1. Press the function key for adding refrigerant.
2. After 30 minutes of operation, open the Charging Ports on low pressure side in Heat Pump.
3. Open the valve for low pressure side in the manifold gauge to recharge the remaining refrigerant.
4. After completing, close the valves in manifold gauge and eliminate the hoses from Charging Ports.

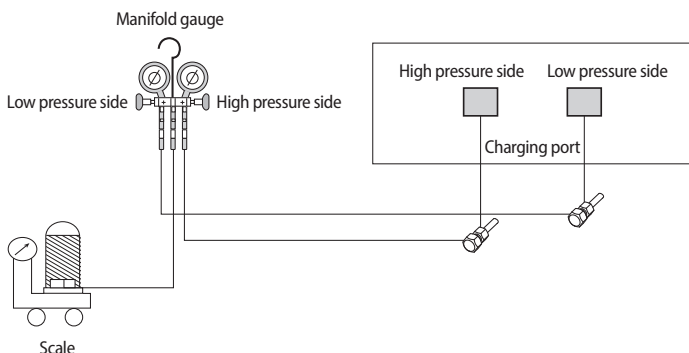

Important information regulation regarding the refrigerant used

-  **CAUTION**
- Inform user if system contains 3 kg or more of fluorinated greenhouse gases. In this case, it has to be checked for leakage at least once every 12 months, according to regulation n°842/2006. This activity has to be covered by qualified personnel only. In case situation above (3 kg or more of R-410A), installer (or recognised person which has responsibility for final check) has to provide a maintenance book, with all the information recorded according to REGULATION(EC) N° 842/2006 OF THE EUROPEAN PARLIAMENT AND OF THE COUNCIL of 17 May 2006 on certain fluorinated greenhouse gases.

Maintenance

It is recommended that annually a competent person

- a Inspects and cleans the line strainer.
- b Checks the operation of the expansion relief valve and temperature & pressure relief valve.
- c Recommissions the cylinder in accordance with the instructions.

Tundish

Install the Tundish in a vertical position within a maximum of 600mm from the temperature and Pressure Relief Valve drain connection. Ensure the expansion relief pipework discharges through the tundish. Tundish pipework must be 22mm with a minimum vertical length of 300mm below tundish.

Maximum permitted length of 22mm pipework is 9m. Each bend or elbow is equivalent to 0.8m of pipework.

All pipework must have continuous fall and discharge in a safe, visible position. If any doubt, refer to Building Regulation G3.

Charging refrigerant

- ▶ The R-410A refrigerant is blended refrigerant. Add only liquid refrigerant.
- ▶ Measure the quantity of the refrigerant according to the length of the liquid side pipe. Add quantity of the refrigerant using a scale.

Important information regulation regarding the refrigerant used

This product contains fluorinated greenhouse gases. Do not vent gases into the atmosphere.



- Inform user if system contains 5 tCO₂e or more of fluorinated greenhouse gases. In this case, it has to be checked for leakage at least once every 12 months, according to regulation n°517/2014. This activity has to be covered by qualified personnel only. In case situation above (5 tCO₂e or more of R-410A), installer (or recognized person which has responsibility for final check) has to provide a maintenance book, with all the information recorded according to REGULATION (EU) N° 517/2014 OF THE EUROPEAN PARLIAMENT AND OF THE COUNCIL of 16 April 2014 on fluorinated greenhouse gases.

Please fill in the following with indelible ink on the refrigerant charge label supplied with this product and on this manual.

- ▶ ① the factory refrigerant charge of the product.
- ▶ ② the additional refrigerant amount charged in the field.
- ▶ ①+② the total refrigerant charge.

Unit	kg	tCO ₂ e
①, a		
②, b		
①+②, c		

Refrigerant type	GWP value
R-410A	2088

- GWP=Global Warming Potential
- Calculating tCO₂e : kg x GWP / 1000



- a Factory refrigerant charge of the product: see unit name plate.
- b Additional refrigerant amount charged in the field. (Refer to the above information for the quantity of refrigerant replenishment.)
- c Total refrigerant charge.
- d Refrigerant cylinder and manifold for charging.



- The filled-out label must be adhered in the proximity of the product charging port. (ex. onto the inside of the stop valve cover.)

Troubleshooting

FAULT	POSSIBLE CAUSE	REMEDY
No water flow from hot taps.	<ol style="list-style-type: none"> 1. Mains supply off. 2. Strainer blocked. 3. Cold water inlet Pressure Reducing Valve incorrectly fitted. 	<ol style="list-style-type: none"> 1. Check and open stopcock. 2. Turn off water supply. Remove strainer and clean. (See Pressure Reducing Valve page 6 Installation Manual) 3. Check and refit as required (see item 3 page 5 of installation manual).
Water from hot taps is cold.	<ol style="list-style-type: none"> 1. Immersion heaters not switched on. 2. Immersion heater thermal cut-out has operated. 3. Programmer set to central heating or not switched on. 4. Boiler not working 5. Motorised valve not operating correctly. 	<ol style="list-style-type: none"> 1. Check and switch on.. 2. Check and reset button. (See thermostat diagram page 9 and safety cut-out on page 4 of installation manual). 3. Check and set to hot water. 4. Check boiler operation. If fault suspected, consult installer or boiler manufacturer. 5. Check wiring and/or plumbing connections to motorized valve.
Intermittent water discharge	<ol style="list-style-type: none"> 1. Reduced internal expansion. 2. Thermal control failure. (Note Water will be hot). 	<ol style="list-style-type: none"> 1. Repressurize expansion vessel. Follow cold water discharge instructions on page 4. 2. Switch off power to immersion heater(s) and boiler supply to the unit. When discharge has stopped, check thermal controls, replace it faulty. Contact a competent person.
Continuous water discharge	<ol style="list-style-type: none"> 1. Cold water inlet Pressure Reducing Valve not working 2. Temperature and pressure relief valve faulty. 3. Expansion relief valve not working correctly. 	<ol style="list-style-type: none"> 1. Check pressure from valve if greater than 2.1 bar replace. (See page 6 of installation manual). 2. As No2 of above. 3. Check and replace if faulty. (See page 6 of installation manual).
Room thermostat does not switch on or not work properly	Wireless room thermostat batteries not Working	Replace new batteries for wireless room thermostat



NOTE

- Disconnect electrical supply before removing any electrical equipment covers.

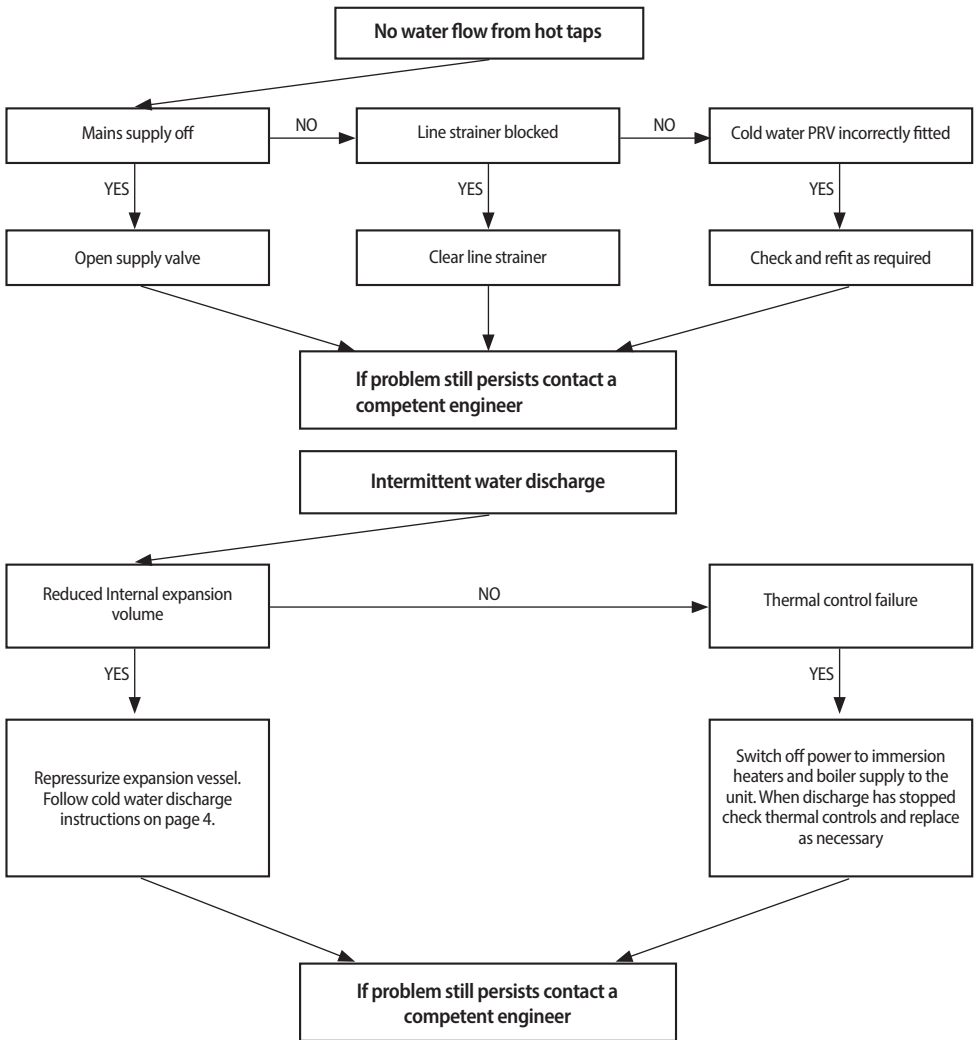

Troubleshooting

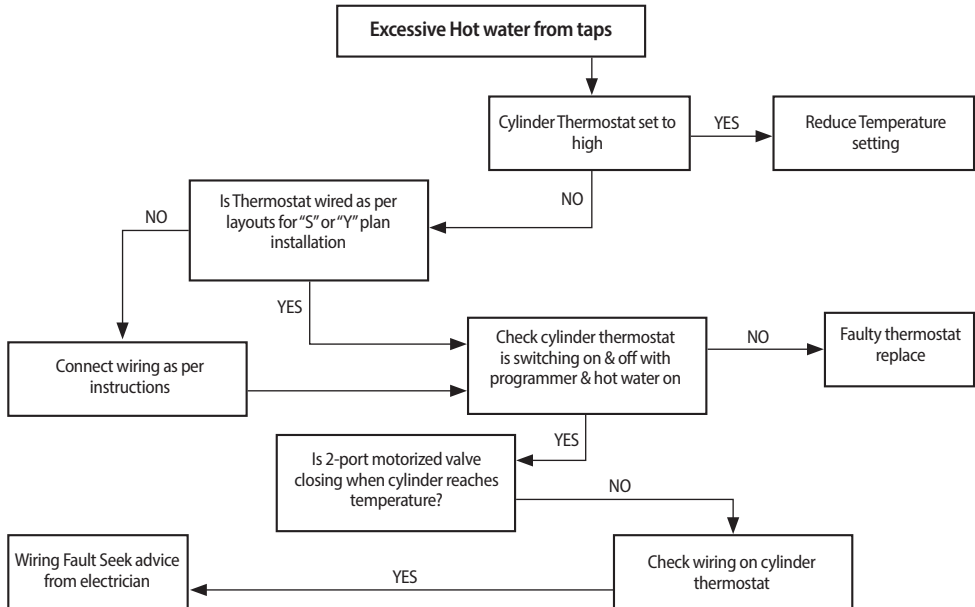
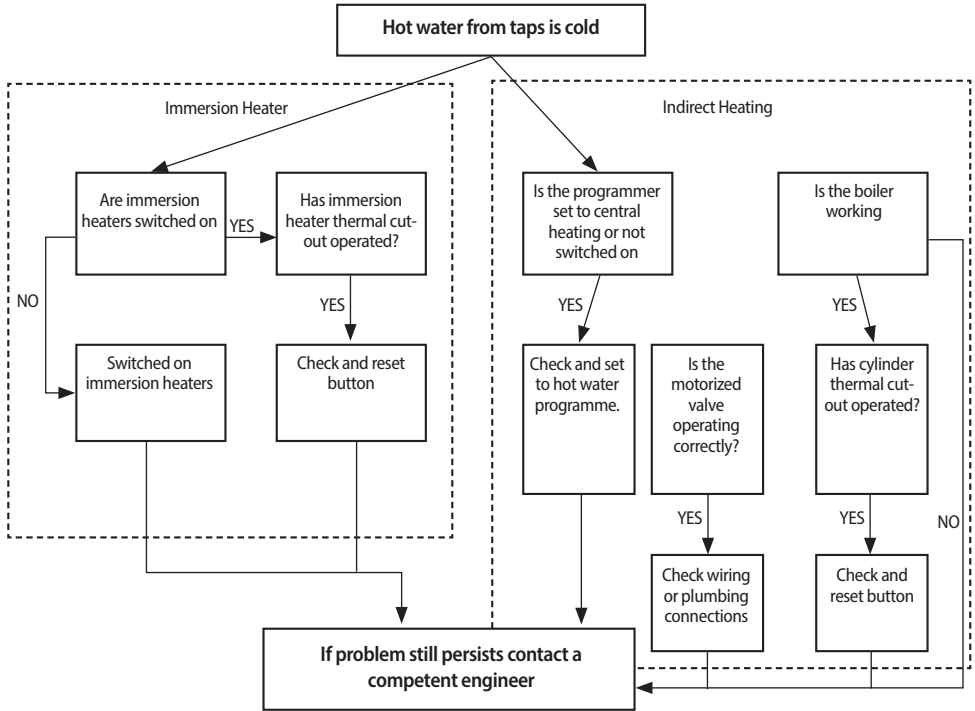

If in doubt at any stage you must consult a qualified technician

Commissioning

Filling up

1. Open a hot tap.
2. Open the cold water supply valve.
3. When water flows from hot tap, close the tap.
4. Allow the system to stabilize for 5 minutes.
5. Open each hot water tap in turn to expel air from the system pipe work.
6. Check for leaks.
7. Manually operate Temperature and Pressure Relief Valve to ensure free water flow through discharge pipe. (Turn knob to left.)

Draining/flushing

1. Turn off mains supply.
2. Connect hose pipe to drain cock at base of cylinder.
3. Open hot tap. Open drain valve and open temperature & pressure relief valve.
4. Allow to drain. Follow commissioning instructions (above) to refill.

Recommissioning instructions

Cold or tepid water discharge from tundish - The tundish should be installed away from electrical devices.

1. Close cold water supply valve.
2. Open a hot tap.
3. Repressurise the expansion vessel air charge to its set level.
4. Close hot tap.
5. Open the cold water supply valve.

Hot water discharge from tundish

This indicates a malfunction of a thermal cut-out, operating thermostat or the combined temperature and pressure relief valve. Turn off the electrical supply to the immersion heater and also isolate an indirect unit from the boiler. Contact the installer or competent engineer.

COMMISSION REGULATION (EU) No 813/2013 ¹⁾

ECODESIGN REQUIREMENTS FOR SPACE HEATER ¹⁾

A	Model(s) : AE090JXYDEH
B	Air-to-water heat pump : yes
C	Water-to-water heat pump : no
D	Brine-to-water heat pump : no
E	Low-temperature heat pump : no
F	Equipped with a supplementary heater : no
G	Heat pump combination heater : no
H	Parameters shall be declared for medium-temperature application, except for low-temperature heat pumps. For low-temperature heat pump, parameters shall be declared for low-temperature application.
I	Parameters shall be declared for average climate conditions.

Item ⁽¹⁾	Symbol ⁽²⁾	Value ⁽³⁾	Unit ⁽⁴⁾
N	Rated heat output ⁽⁵⁾	Prated ⁽⁶⁾	6 kW
Q	Declared capacity for heating for part load at indoor temperature 20 °C and outdoor temperature T _j		
-	T _j = -7 °C	P _{dh}	5.5 kW
	T _j = +2 °C	P _{dh}	3.3 kW
	T _j = +7 °C	P _{dh}	2.1 kW
	T _j = +12 °C	P _{dh}	1.0 kW
T	T _j = bivalent temperature	P _{dh}	6.2 kW
U	T _j = operation limit temperature	P _{dh}	6.2 kW
V	For air-to-water heat pumps T _j = -15 °C (if TOL < -20 °C)	P _{dh}	- kW
W	Bivalent temperature	T _{biv}	-10 °C
Y	Cycling interval capacity for heating	P _{cyh}	- kW
AB	Degradation co-efficient ⁽⁷⁾	C _{dh}	0.9
AD	Power consumption in modes other than active mode		
AF	Off mode	P _{off}	0.080 kW
AG	Thermostat-off mode	P _{to}	0.011 kW
AH	Standby mode	P _{st}	0.011 kW
AI	Crankcase heater mode	P _{ck}	0.000 kW
AK	Other items		
AL	Capacity control	variable ⁽⁸⁾	
AP	Sound power level, indoors/ outdoors	L _{wa}	-/63 dB
AQ	Emissions of nitrogen oxides	NO _x	- mg/kWh
AS	For heat pump combination heater		
AT	Declared load profile	-	
AV	Daily electricity consumption	Q _{elec}	- kWh
AX	Contact details	http://www.samsung.com	

Item ⁽¹⁾	Symbol ⁽²⁾	Value ⁽³⁾	Unit ⁽⁴⁾
P	Seasonal space heating energy efficiency	η _s	126 %
R	Declared coefficient of performance or primary energy ratio for part load at indoor temperature 20 °C and outdoor temperature T _j		
-	T _j = -7 °C	COP _d ⁽⁵⁾	1.89 -
	T _j = +2 °C	COP _d ⁽⁵⁾	3.01 -
	T _j = +7 °C	COP _d ⁽⁵⁾	4.25 -
	T _j = +12 °C	COP _d ⁽⁵⁾	6.78 -
T	T _j = bivalent temperature	COP _d ⁽⁵⁾	1.77 -
U	T _j = operation limit temperature	COP _d ⁽⁵⁾	1.77 -
V	For air-to-water heat pumps T _j = -15 °C (if TOL < -20 °C)	COP _d ⁽⁵⁾	- -
X	For air-to-water heat pumps: Operation limit temperature	TOL	-10 °C
Z	Cycling interval efficiency	COP _{cyh} ^(6A)	- -
AC	Heating water operating limit temperature	WTOL	- °C
AE	Supplementary heater		
N	Rated heat output ⁽⁷⁾	P _{sup}	- kW
AJ	Type of energy input		
AK	Other items		
AN	For air-to-water heat pumps : Rated air flow rate, outdoors	-	53 m ³ /h ^(6B)
AR	For water-/brine-to-water heat pumps: Rated brine or water flow rate, outdoor heat exchanger	-	m ³ /h ^(6B)
AS	For heat pump combination heater		
AU	Water heating energy efficiency	η _{wh}	- %
AW	Daily fuel consumption	Q _{heat}	- kWh

AY ⁽⁷⁾ For heat pump space heaters and heat pump combination heaters, the rated that output Prated is equal to the design load for heating Pdesignh, and the rated heat output of a supplementary heater Psup is equal to the supplementary capacity for heating sup(Tj).

AZ ^(7A) If C_{dh} is not determined by measurement then the default degradation coefficient is C_{dh} = 0.9.

BA ⁽⁸⁾ Precautions as described in the installation/user manual must be taken when assembling, installing and maintaining this product.

BB ⁽⁹⁾ If you are a professional looking for information on non-destructive disassembly and dismantling, please send an email to: erims.sec@samsung.com

A	Model(s) : AE090JXYDGH
B	Air-to-water heat pump : yes
C	Water-to-water heat pump : no
D	Brine-to-water heat pump : no
E	Low-temperature heat pump : no
F	Equipped with a supplementary heater : no
G	Heat pump combination heater : no
H	Parameters shall be declared for medium-temperature application, except for low-temperature heat pumps. For low-temperature heat pump, parameters shall be declared for low-temperature application.
I	Parameters shall be declared for average climate conditions.

	Item ⁽¹⁾	Symbol ^(K)	Value ^(L)	Unit ^(M)
N	Rated heat output ^(?)	Prated ⁽⁶⁾	5	kW
Q	Declared capacity for heating for part load at indoor temperature 20 °C and outdoor temperature T _j			
-	T _j = -7 °C	P _{dh}	4.4	kW
-	T _j = +2 °C	P _{dh}	2.7	kW
-	T _j = +7 °C	P _{dh}	1.7	kW
-	T _j = +12 °C	P _{dh}	0.8	kW
T	T _j = bivalent temperature	P _{dh}	5.0	kW
U	T _j = operation limit temperature	P _{dh}	5.0	kW
V	For air-to-water heat pumps T _j = -15 °C (if TOL < -20 °C)	P _{dh}	-	kW
W	Bivalent temperature	T _{biv}	-10	°C
Y	Cycling interval capacity for heating	P _o ych	-	kW
AB	Degradation co-efficient ^(?)	C _{dh}	0.9	-
AD	Power consumption in modes other than active mode			
AF	Off mode	P _{off}	0.080	kW
AG	Thermostat-off mode	P _{to}	0.011	kW
AH	Standby mode	P _{sb}	0.011	kW
AI	Crankcase heater mode	P _{ck}	0.000	kW
AK	Other items			
AL	Capacity control		variable ^(AM)	
AP	Sound power level, indoors/ outdoors	L _{wa}	-/63	dB
AQ	Emissions of nitrogen oxides	NO _x	-	mg/kWh
AS	For heat pump combination heater			
AT	Declared load profile		-	
AV	Daily electricity consumption	Q _{elec}	-	kWh
AX	Contact details	http://www.samsung.com		

	Item ⁽¹⁾	Symbol ^(K)	Value ^(L)	Unit ^(M)
P	Seasonal space heating energy efficiency	η _s	125	%
R	Declared coefficient of performance or primary energy ratio for part load at indoor temperature 20 °C and outdoor temperature T _j			
-	T _j = -7 °C	COP _d ⁽⁵⁾	1.88	-
-	T _j = +2 °C	COP _d ⁽⁵⁾	3.14	-
-	T _j = +7 °C	COP _d ⁽⁵⁾	4.60	-
-	T _j = +12 °C	COP _d ⁽⁵⁾	6.69	-
T	T _j = bivalent temperature	COP _d ⁽⁵⁾	1.65	-
U	T _j = operation limit temperature	COP _d ⁽⁵⁾	1.65	-
V	For air-to-water heat pumps T _j = -15 °C (if TOL < -20 °C)	COP _d ⁽⁵⁾	-	-
X	For air-to-water heat pumps: Operation limit temperature	TOL	-10	°C
Z	Cycling interval efficiency	COP _{yc} ^(AM)	-	-
AC	Heating water operating limit temperature	WTOL	-	°C
AE	Supplementary heater			
N	Rated heat output ^(?)	P _{sup}	-	kW
AJ	Type of energy input			
AK	Other items			
AN	For air-to-water heat pumps : Rated air flow rate, outdoors	-	53	m ³ /h ^(AO)
AR	For water-/brine-to-water heat pumps: Rated brine or water flow rate, outdoor heat exchanger	-	-	m ³ /h ^(AO)
AS	For heat pump combination heater			
AU	Water heating energy efficiency	η _{wh}	-	%
AW	Daily fuel consumption	Q _{fuel}	-	kWh

AY ⁽⁷⁾ For heat pump space heaters and heat pump combination heaters, the rated that output Prated is equal to the design load for heating Pdesignh, and the rated heat output of a supplementary heater Psup is equal to the supplementary capacity for heating sup(T_j).

AZ ⁽⁸⁾ If C_{dh} is not determined by measurement then the default degradation coefficient is C_{dh} = 0.9.

BA ⁽¹⁾ Precautions as described in the installation/user manual must be taken when assembling, installing and maintaining this product.

BB ⁽²⁾ If you are a professional looking for information on non-destructive disassembly and dismantling, please send an email to: erims.sec@samsung.com

COMMISSION REGULATION (EU) No 813/2013 ¹⁾

A	Model(s) : AE120JXYDEH
B	Air-to-water heat pump : yes
C	Water-to-water heat pump : no
D	Brine-to-water heat pump : no
E	Low-temperature heat pump : no
F	Equipped with a supplementary heater : no
G	Heat pump combination heater : no
H	Parameters shall be declared for medium-temperature application, except for low-temperature heat pumps. For low-temperature heat pump, parameters shall be declared for low-temperature application.
I	Parameters shall be declared for average climate conditions.

Item ⁽²⁾	Symbol ⁽³⁾	Value ⁽²⁾	Unit ⁽⁴⁾
N	Rated heat output(*)	Prated ⁽⁶⁾	8 kW
Q	Declared capacity for heating for part load at indoor temperature 20 °C and outdoor temperature Tj		
-	Tj = -7 °C	Pdh	7.1 kW
	Tj = +2 °C	Pdh	4.3 kW
	Tj = +7 °C	Pdh	2.8 kW
	Tj = +12 °C	Pdh	1.2 kW
T	Tj = bivalent temperature	Pdh	8.0 kW
U	Tj = operation limit temperature	Pdh	8.0 kW
V	For air-to-water heat pumps Tj = -15 °C (if TOL < -20 °C)	Pdh	- kW
W	Bivalent temperature	Tbiv	-10 °C
Y	Cycling interval capacity for heating	Pcyh	- kW
AB	Degradation co-efficient ⁽⁷⁾	Cdh	0.9
AD	Power consumption in modes other than active mode		
AF	Off mode	Poff	0.080 kW
AG	Thermostat-off mode	Pto	0.011 kW
AH	Standby mode	Psb	0.011 kW
AI	Crankcase heater mode	Pck	0.000 kW
AK	Other items		
AL	Capacity control	variable ^(8M)	
AP	Sound power level, indoors/ outdoors	Lwa	-/64 dB
AQ	Emissions of nitrogen oxides	NOx	- mg/kWh
AS	For heat pump combination heater		
AT	Declared load profile	-	
AV	Daily electricity consumption	Qelec	- kWh
AX	Contact details	http://www.samsung.com	

Item ⁽²⁾	Symbol ⁽³⁾	Value ⁽²⁾	Unit ⁽⁴⁾
P	Seasonal space heating energy efficiency	ηs	115 %
R	Declared coefficient of performance or primary energy ratio for part load at indoor temperature 20 °C and outdoor temperature Tj		
-	Tj = -7 °C	COPd ⁽⁵⁾	1.76
	Tj = +2 °C	COPd ⁽⁵⁾	2.79
	Tj = +7 °C	COPd ⁽⁵⁾	3.73
	Tj = +12 °C	COPd ⁽⁵⁾	6.71
T	Tj = bivalent temperature	COPd ⁽⁵⁾	1.51
U	Tj = operation limit temperature	COPd ⁽⁵⁾	1.51
V	For air-to-water heat pumps Tj = -15 °C (if TOL < -20 °C)	COPd ⁽⁵⁾	-
X	For air-to-water heat pumps: Operation limit temperature	TOL	-10 °C
Z	Cycling interval efficiency	COPcyc ^(6A)	-
AC	Heating water operating limit temperature	WTOL	- °C
AE	Supplementary heater		
N	Rated heat output(*)	Psup	- kW
AJ	Type of energy input		
AK	Other items		
AN	For air-to-water heat pumps : Rated air flow rate, outdoors	-	108 m ³ /h ^(6B)
AR	For water-/brine-to-water heat pumps: Rated brine or water flow rate, outdoor heat exchanger	-	- m ³ /h ^(6B)
AS	For heat pump combination heater		
AU	Water heating energy efficiency	ηwh	- %
AW	Daily fuel consumption	Qfuel	- kWh

AY ⁽⁷⁾ For heat pump space heaters and heat pump combination heaters, the rated that output Prated is equal to the design load for heating Pdesignh, and the rated heat output of a supplementary heater Psup is equal to the supplementary capacity for heating sup(Tj).

AZ ⁽⁷⁾ If Cdh is not determined by measurement then the default degradation coefficient is Cdh = 0.9.

BA ⁽¹⁾ Precautions as described in the installation/user manual must be taken when assembling, installing and maintaining this product.

BB ⁽²⁾ If you are a professional looking for information on non-destructive disassembly and dismantling, please send an email to: erims.sec@samsung.com

A	Model(s) : AE120JXYDGH
B	Air-to-water heat pump : yes
C	Water-to-water heat pump : no
D	Brine-to-water heat pump : no
E	Low-temperature heat pump : no
F	Equipped with a supplementary heater : no
G	Heat pump combination heater : no
H	Parameters shall be declared for medium-temperature application, except for low-temperature heat pumps. For low-temperature heat pump, parameters shall be declared for low-temperature application.
I	Parameters shall be declared for average climate conditions.

	Item ⁽¹⁾	Symbol ^(K)	Value ^(L)	Unit ^(M)
N	Rated heat output(*)	Prated ⁽⁶⁾	8	kW
Q	Declared capacity for heating for part load at indoor temperature 20 °C and outdoor temperature Tj			
-	Tj = -7 °C	Pdh	7.1	kW
	Tj = +2 °C	Pdh	4.3	kW
	Tj = +7 °C	Pdh	2.8	kW
	Tj = +12 °C	Pdh	1.2	kW
T	Tj = bivalent temperature	Pdh	8.0	kW
U	Tj = operation limit temperature	Pdh	8.0	kW
V	For air-to-water heat pumps Tj = -15 °C (if TOL < -20 °C)	Pdh	-	kW
W	Bivalent temperature	Tbiv	-10	°C
Y	Cycling interval capacity for heating	Psych	-	kW
AB	Degradation co-efficient(**)	Cdh	0.9	-
AD	Power consumption in modes other than active mode			
AF	Off mode	Poff	0.080	kW
AG	Thermostat-off mode	Pto	0.011	kW
AH	Standby mode	Psb	0.011	kW
AI	Crankcase heater mode	Pcx	0.000	kW
AK	Other items			
AL	Capacity control		variable ^(MM)	
AP	Sound power level, indoors/ outdoors	Lwa	-/64	dB
AQ	Emissions of nitrogen oxides	NOx	-	mg/kWh
AS	For heat pump combination heater			
AT	Declared load profile		-	
AV	Daily electricity consumption	Qelec	-	kWh
AX	Contact details	http://www.samsung.com		

	Item ⁽¹⁾	Symbol ^(K)	Value ^(L)	Unit ^(M)
P	Seasonal space heating energy efficiency	η_s	115	%
R	Declared coefficient of performance or primary energy ratio for part load at indoor temperature 20 °C and outdoor temperature Tj			
-	Tj = -7 °C	COPd ⁽⁵⁾	1.76	-
	Tj = +2 °C	COPd ⁽⁵⁾	2.79	-
	Tj = +7 °C	COPd ⁽⁵⁾	3.73	-
	Tj = +12 °C	COPd ⁽⁵⁾	6.71	-
T	Tj = bivalent temperature	COPd ⁽⁵⁾	1.51	-
U	Tj = operation limit temperature	COPd ⁽⁵⁾	1.51	-
V	For air-to-water heat pumps Tj = -15 °C (if TOL < -20 °C)	COPd ⁽⁵⁾	-	-
X	For air-to-water heat pumps: Operation limit temperature	TOL	-10	°C
Z	Cycling interval efficiency	COP _{yc} ^(AA)	-	-
AC	Heating water operating limit temperature	WTOL	-	°C
AE	Supplementary heater			
N	Rated heat output(*)	Psup	-	kW
AJ	Type of energy input			
AK	Other items			
AN	For air-to-water heat pumps : Rated air flow rate, outdoors	-	108	m ³ /h ^(AO)
AR	For water-/brine-to-water heat pumps: Rated brine or water flow rate, outdoor heat exchanger	-	-	m ³ /h ^(AO)
AS	For heat pump combination heater			
AU	Water heating energy efficiency	η_{wh}	-	%
AW	Daily fuel consumption	Q _{fuel}	-	kWh

AY ⁽⁷⁾ For heat pump space heaters and heat pump combination heaters, the rated that output Prated is equal to the design load for heating Pdesignh, and the rated heat output of a supplementary heater Psup is equal to the supplementary capacity for heating sup(Tj).

AZ ⁽⁸⁾ If Cdh is not determined by measurement then the default degradation coefficient is Cdh = 0.9.

BA ⁽¹⁾ Precautions as described in the installation/user manual must be taken when assembling, installing and maintaining this product.

BB ⁽²⁾ If you are a professional looking for information on non-destructive disassembly and dismantling, please send an email to: erims.sec@samsung.com

COMMISSION REGULATION (EU) No 813/2013 ¹⁾

A	Model(s) : AE140JXYDEH
B	Air-to-water heat pump : yes
C	Water-to-water heat pump : no
D	Brine-to-water heat pump : no
E	Low-temperature heat pump : no
F	Equipped with a supplementary heater : no
G	Heat pump combination heater : no
H	Parameters shall be declared for medium-temperature application, except for low-temperature heat pumps. For low-temperature heat pump, parameters shall be declared for low-temperature application.
I	Parameters shall be declared for average climate conditions.

Item ⁽²⁾	Symbol ⁽³⁾	Value ⁽³⁾	Unit ⁽⁴⁾
N	Rated heat output(*)	Prated ⁽⁶⁾	9 kW
Q	Declared capacity for heating for part load at indoor temperature 20 °C and outdoor temperature T _j		
-	T _j = -7 °C	P _{dh}	7.5 kW
	T _j = +2 °C	P _{dh}	4.6 kW
	T _j = +7 °C	P _{dh}	2.9 kW
	T _j = +12 °C	P _{dh}	1.3 kW
T	T _j = bivalent temperature	P _{dh}	8.5 kW
U	T _j = operation limit temperature	P _{dh}	8.5 kW
V	For air-to-water heat pumps T _j = -15 °C (if TOL < -20 °C)	P _{dh}	- kW
W	Bivalent temperature	T _{biv}	-10 °C
Y	Cycling interval capacity for heating	P _{cyh}	- kW
AB	Degradation co-efficient ⁽⁷⁾	C _{dh}	0.9
AD	Power consumption in modes other than active mode		
AF	Off mode	P _{off}	0.080 kW
AG	Thermostat-off mode	P _{to}	0.011 kW
AH	Standby mode	P _{st}	0.011 kW
AI	Crankcase heater mode	P _{ck}	0.000 kW
AK	Other items		
AL	Capacity control	variable ^(4M)	
AP	Sound power level, indoors/ outdoors	L _{wa}	-/65 dB
AQ	Emissions of nitrogen oxides	NO _x	- mg/kWh
AS	For heat pump combination heater		
AT	Declared load profile	-	
AV	Daily electricity consumption	Q _{elec}	- kWh
AX	Contact details	http://www.samsung.com	

Item ⁽²⁾	Symbol ⁽³⁾	Value ⁽³⁾	Unit ⁽⁴⁾
P	Seasonal space heating energy efficiency	η _s	114 %
R	Declared coefficient of performance or primary energy ratio for part load at indoor temperature 20 °C and outdoor temperature T _j		
-	T _j = -7 °C	COP _d ⁽⁵⁾	1.77
	T _j = +2 °C	COP _d ⁽⁵⁾	2.79
	T _j = +7 °C	COP _d ⁽⁵⁾	3.55
	T _j = +12 °C	COP _d ⁽⁵⁾	6.54
T	T _j = bivalent temperature	COP _d ⁽⁵⁾	1.53
U	T _j = operation limit temperature	COP _d ⁽⁵⁾	1.53
V	For air-to-water heat pumps T _j = -15 °C (if TOL < -20 °C)	COP _d ⁽⁵⁾	-
X	For air-to-water heat pumps: Operation limit temperature	TOL	-10 °C
Z	Cycling interval efficiency	COP _{cyh} ^(4M)	-
AC	Heating water operating limit temperature	WTOL	- °C
AE	Supplementary heater		
N	Rated heat output(*)	P _{sup}	- kW
AJ	Type of energy input		
AK	Other items		
AN	For air-to-water heat pumps : Rated air flow rate, outdoors	-	108 m ³ /h ^(4M)
AR	For water-/brine-to-water heat pumps: Rated brine or water flow rate, outdoor heat exchanger	-	- m ³ /h ^(4M)
AS	For heat pump combination heater		
AU	Water heating energy efficiency	η _{wh}	- %
AW	Daily fuel consumption	Q _{fuel}	- kWh

AY ⁽⁷⁾ For heat pump space heaters and heat pump combination heaters, the rated that output Prated is equal to the design load for heating Pdesignh, and the rated heat output of a supplementary heater Psup is equal to the supplementary capacity for heating sup(Tj).

AZ ⁽⁷⁾ If Cdh is not determined by measurement then the default degradation coefficient is Cdh = 0.9.

BA ⁽¹⁾ Precautions as described in the installation/user manual must be taken when assembling, installing and maintaining this product.

BB ⁽²⁾ If you are a professional looking for information on non-destructive disassembly and dismantling, please send an email to: erims.sec@samsung.com

A	Model(s) : AE140JXYDGH
B	Air-to-water heat pump : yes
C	Water-to-water heat pump : no
D	Brine-to-water heat pump : no
E	Low-temperature heat pump : no
F	Equipped with a supplementary heater : no
G	Heat pump combination heater : no
H	Parameters shall be declared for medium-temperature application, except for low-temperature heat pumps. For low-temperature heat pump, parameters shall be declared for low-temperature application.
I	Parameters shall be declared for average climate conditions.

	Item ⁽¹⁾	Symbol ^(K)	Value ^(L)	Unit ^(M)
N	Rated heat output(*)	Prated ⁽⁶⁾	9	kW
Q	Declared capacity for heating for part load at indoor temperature 20 °C and outdoor temperature Tj			
-	Tj = -7 °C	Pdh	7.5	kW
	Tj = +2 °C	Pdh	4.6	kW
	Tj = +7 °C	Pdh	2.9	kW
	Tj = +12 °C	Pdh	1.3	kW
T	Tj = bivalent temperature	Pdh	8.5	kW
U	Tj = operation limit temperature	Pdh	8.5	kW
V	For air-to-water heat pumps Tj = -15 °C (if TOL < -20 °C)	Pdh	-	kW
W	Bivalent temperature	Tbiv	-10	°C
Y	Cycling interval capacity for heating	Po _{ych}	-	kW
AB	Degradation co-efficient(**)	Cdh	0.9	-
AD	Power consumption in modes other than active mode			
AF	Off mode	P _{off}	0.080	kW
AG	Thermostat-off mode	P _{to}	0.011	kW
AH	Standby mode	P _{sb}	0.011	kW
AI	Crankcase heater mode	P _{ck}	0.000	kW
AK	Other items			
AL	Capacity control		variable ^(MM)	
AP	Sound power level, indoors/ outdoors	L _{wa}	-/65	dB
AQ	Emissions of nitrogen oxides	NO _x	-	mg/kWh
AS	For heat pump combination heater			
AT	Declared load profile		-	
AV	Daily electricity consumption	Q _{elec}	-	kWh
AX	Contact details	http://www.samsung.com		

	Item ⁽¹⁾	Symbol ^(K)	Value ^(L)	Unit ^(M)
P	Seasonal space heating energy efficiency	η _s	114	%
R	Declared coefficient of performance or primary energy ratio for part load at indoor temperature 20 °C and outdoor temperature Tj			
-	Tj = -7 °C	COP _d ⁽⁵⁾	1.77	-
	Tj = +2 °C	COP _d ⁽⁵⁾	2.79	-
	Tj = +7 °C	COP _d ⁽⁵⁾	3.55	-
	Tj = +12 °C	COP _d ⁽⁵⁾	6.54	-
T	Tj = bivalent temperature	COP _d ⁽⁵⁾	1.53	-
U	Tj = operation limit temperature	COP _d ⁽⁵⁾	1.53	-
V	For air-to-water heat pumps Tj = -15 °C (if TOL < -20 °C)	COP _d ⁽⁵⁾	-	-
X	For air-to-water heat pumps: Operation limit temperature	TOL	-10	°C
Z	Cycling interval efficiency	COP _{yc} ^(AA)	-	-
AC	Heating water operating limit temperature	WTOL	-	°C
AE	Supplementary heater			
N	Rated heat output(*)	P _{sup}	-	kW
AJ	Type of energy input			
AK	Other items			
AN	For air-to-water heat pumps : Rated air flow rate, outdoors	-	108	m ³ /h ^(AO)
AR	For water-/brine-to-water heat pumps: Rated brine or water flow rate, outdoor heat exchanger	-	-	m ³ /h ^(AO)
AS	For heat pump combination heater			
AU	Water heating energy efficiency	η _{wh}	-	%
AW	Daily fuel consumption	Q _{fuel}	-	kWh

AY ⁽⁷⁾ For heat pump space heaters and heat pump combination heaters, the rated that output Prated is equal to the design load for heating Pdesignh, and the rated heat output of a supplementary heater Psup is equal to the supplementary capacity for heating sup(Tj).

AZ ⁽⁷⁾ If Cdh is not determined by measurement then the default degradation coefficient is Cdh = 0.9.

BA ⁽¹⁾ Precautions as described in the installation/user manual must be taken when assembling, installing and maintaining this product.

BB ⁽²⁾ If you are a professional looking for information on non-destructive disassembly and dismantling, please send an email to: erims.sec@samsung.com

COMMISSION REGULATION (EU) No 813/2013¹⁾

A	Model(s) : AE160JXYDEH
B	Air-to-water heat pump : yes
C	Water-to-water heat pump : no
D	Brine-to-water heat pump : no
E	Low-temperature heat pump : no
F	Equipped with a supplementary heater : no
G	Heat pump combination heater : no
H	Parameters shall be declared for medium-temperature application, except for low-temperature heat pumps. For low-temperature heat pump, parameters shall be declared for low-temperature application.
I	Parameters shall be declared for average climate conditions.

Item ⁽²⁾	Symbol ⁽³⁾	Value ⁽¹⁾	Unit ⁽⁴⁾	
N	Rated heat output(*)	Prated ⁽⁶⁾	10 kW	
Q	Declared capacity for heating for part load at indoor temperature 20 °C and outdoor temperature Tj			
-	Tj = -7 °C	Pdh	8.4 kW	
	Tj = +2 °C	Pdh	5.1 kW	
	Tj = +7 °C	Pdh	3.3 kW	
	Tj = +12 °C	Pdh	1.5 kW	
T	Tj = bivalent temperature	Pdh	9.5 kW	
U	Tj = operation limit temperature	Pdh	9.5 kW	
V	For air-to-water heat pumps Tj = -15 °C (if TOL < -20 °C)	Pdh	- kW	
W	Bivalent temperature	Tbiv	-10 °C	
Y	Cycling interval capacity for heating	Pcyh	- kW	
AB	Degradation co-efficient(*)	Cdh	0.9	
AD	Power consumption in modes other than active mode			
AF	Off mode	Poff	0.080 kW	
AG	Thermostat-off mode	Pto	0.011 kW	
AH	Standby mode	Psb	0.011 kW	
AI	Crankcase heater mode	Pck	0.000 kW	
AK	Other items			
AL	Capacity control	variable ^(4M)		
AP	Sound power level, indoors/ outdoors	Lwa	-/66 dB	
AQ	Emissions of nitrogen oxides	NOx	- mg/kWh	
AS	For heat pump combination heater			
AT	Declared load profile	-		
AV	Daily electricity consumption	Qelec	- kWh	
AX	Contact details	http://www.samsung.com		

Item ⁽²⁾	Symbol ⁽³⁾	Value ⁽¹⁾	Unit ⁽⁴⁾	
P	Seasonal space heating energy efficiency	ηs	112 %	
R	Declared coefficient of performance or primary energy ratio for part load at indoor temperature 20 °C and outdoor temperature Tj			
-	Tj = -7 °C	COPd ⁽⁵⁾	1.75	-
	Tj = +2 °C	COPd ⁽⁵⁾	2.62	-
	Tj = +7 °C	COPd ⁽⁵⁾	3.73	-
	Tj = +12 °C	COPd ⁽⁵⁾	6.80	-
T	Tj = bivalent temperature	COPd ⁽⁵⁾	1.57	-
U	Tj = operation limit temperature	COPd ⁽⁵⁾	1.57	-
V	For air-to-water heat pumps Tj = -15 °C (if TOL < -20 °C)	COPd ⁽⁵⁾	-	-
X	For air-to-water heat pumps: Operation limit temperature	TOL	-10 °C	
Z	Cycling interval efficiency	COPcyc ^(4M)	-	-
AC	Heating water operating limit temperature	WTOL	-	°C
AE	Supplementary heater			
N	Rated heat output(*)	Psup	-	kW
AJ	Type of energy input			
AK	Other items			
AN	For air-to-water heat pumps : Rated air flow rate, outdoors	-	108	m ³ /h ^(4M)
AR	For water-/brine-to-water heat pumps: Rated brine or water flow rate, outdoor heat exchanger	-	-	m ³ /h ^(4M)
AS	For heat pump combination heater			
AU	Water heating energy efficiency	ηwh	-	%
AW	Daily fuel consumption	Qfuel	-	kWh

AY ⁽⁷⁾ For heat pump space heaters and heat pump combination heaters, the rated that output Prated is equal to the design load for heating Pdesignh, and the rated heat output of a supplementary heater Psup is equal to the supplementary capacity for heating sup(Tj).

AZ ⁽⁷⁾ If Cdh is not determined by measurement then the default degradation coefficient is Cdh = 0.9.

BA ⁽⁸⁾ Precautions as described in the installation/user manual must be taken when assembling, installing and maintaining this product.

BB ⁽⁹⁾ If you are a professional looking for information on non-destructive disassembly and dismantling, please send an email to: erims.sec@samsung.com

A	Model(s) : AE160JXYDGH
B	Air-to-water heat pump : yes
C	Water-to-water heat pump : no
D	Brine-to-water heat pump : no
E	Low-temperature heat pump : no
F	Equipped with a supplementary heater : no
G	Heat pump combination heater : no
H	Parameters shall be declared for medium-temperature application, except for low-temperature heat pumps. For low-temperature heat pump, parameters shall be declared for low-temperature application.
I	Parameters shall be declared for average climate conditions.

	Item ⁽¹⁾	Symbol ^(K)	Value ^(L)	Unit ^(M)
N	Rated heat output ^(?)	Prated ⁽⁶⁾	10	kW
Q	Declared capacity for heating for part load at indoor temperature 20 °C and outdoor temperature T _j			
-	T _j = -7 °C	P _{dh}	8.4	kW
	T _j = +2 °C	P _{dh}	5.1	kW
	T _j = +7 °C	P _{dh}	3.3	kW
	T _j = +12 °C	P _{dh}	1.5	kW
T	T _j = bivalent temperature	P _{dh}	9.5	kW
U	T _j = operation limit temperature	P _{dh}	9.5	kW
V	For air-to-water heat pumps T _j = -15 °C (if TOL < -20 °C)	P _{dh}	-	kW
W	Bivalent temperature	T _{biv}	-10	°C
Y	Cycling interval capacity for heating	P _o ych	-	kW
AB	Degradation co-efficient ^(?)	C _{dh}	0.9	-
AD	Power consumption in modes other than active mode			
AF	Off mode	P _{off}	0.080	kW
AG	Thermostat-off mode	P _{to}	0.011	kW
AH	Standby mode	P _{sb}	0.011	kW
AI	Crankcase heater mode	P _{ck}	0.000	kW
AK	Other items			
AL	Capacity control		variable ^(AM)	
AP	Sound power level, indoors/ outdoors	L _{wa}	-/66	dB
AQ	Emissions of nitrogen oxides	NO _x	-	mg/kWh
AS	For heat pump combination heater			
AT	Declared load profile		-	
AV	Daily electricity consumption	Q _{elec}	-	kWh
AX	Contact details	http://www.samsung.com		

	Item ⁽¹⁾	Symbol ^(K)	Value ^(L)	Unit ^(M)
P	Seasonal space heating energy efficiency	η _s	112	%
R	Declared coefficient of performance or primary energy ratio for part load at indoor temperature 20 °C and outdoor temperature T _j			
-	T _j = -7 °C	COP _d ⁽⁵⁾	1.75	-
	T _j = +2 °C	COP _d ⁽⁵⁾	2.62	-
	T _j = +7 °C	COP _d ⁽⁵⁾	3.73	-
	T _j = +12 °C	COP _d ⁽⁵⁾	6.80	-
T	T _j = bivalent temperature	COP _d ⁽⁵⁾	1.57	-
U	T _j = operation limit temperature	COP _d ⁽⁵⁾	1.57	-
V	For air-to-water heat pumps T _j = -15 °C (if TOL < -20 °C)	COP _d ⁽⁵⁾	-	-
X	For air-to-water heat pumps: Operation limit temperature	TOL	-10	°C
Z	Cycling interval efficiency	COP _{yc} ^(AM)	-	-
AC	Heating water operating limit temperature	WTOL	-	°C
AE	Supplementary heater			
N	Rated heat output ^(?)	P _{sup}	-	kW
AJ	Type of energy input			
AK	Other items			
AN	For air-to-water heat pumps : Rated air flow rate, outdoors	-	108	m ³ /h ^(AO)
AR	For water-/brine-to-water heat pumps: Rated brine or water flow rate, outdoor heat exchanger	-	-	m ³ /h ^(AO)
AS	For heat pump combination heater			
AU	Water heating energy efficiency	η _{wh}	-	%
AW	Daily fuel consumption	Q _{fuel}	-	kWh

AY ⁽⁷⁾ For heat pump space heaters and heat pump combination heaters, the rated that output Prated is equal to the design load for heating Pdesignh, and the rated heat output of a supplementary heater Psup is equal to the supplementary capacity for heating sup(T_j).

AZ ⁽⁸⁾ If C_{dh} is not determined by measurement then the default degradation coefficient is C_{dh} = 0.9.

BA ⁽¹⁾ Precautions as described in the installation/user manual must be taken when assembling, installing and maintaining this product.

BB ⁽²⁾ If you are a professional looking for information on non-destructive disassembly and dismantling, please send an email to: erims.sec@samsung.com

COMMISSION REGULATION (EU) No 813/2013¹⁾

No	English(EN)	Bulgarian(BG)	Spanish(ES)	Czech(CS)
I	COMMISSION REGULATION (EU) No 813/2013	РЕГЛАМЕНТ (ЕС) № 813/2013 НА КОМИСИЯТА	REGLAMENTO (UE) No 813/2013 DE LA COMISIÓN	NAŘÍZENÍ KOMISE (EU) č. 813/2013
II	ECODESIGN REQUIREMENTS FOR SPACE HEATER	Изискванията за екопроектиране на отоплителен топлоизточник	Los requisitos de diseño ecológico de aparato de calefacción	Požadavky na ekodesign pro vytápění vnitřních prostorů
A	Model(s): [information identifying the model(s) to which the information relates]	Модел/моделни: [информация за определяне на модела(ите), за който(ито) тя се отнася]	Modelos: [Datos que identifican el modelo o modelos a que se refiere la información]	Model/y: [informace k určení modelu/ů, na který/é se informace vztahují]
B	Air-to-water heat pump: [yes/no]	Термопомпа „въздух-вода“: [да/не]	Bomba de calor aire-agua: [sí/no]	Teplné čerpadlo vzduch-voda: [ano/ne]
C	Water-to-water heat pump: [yes/no]	Термопомпа „вода-вода“: [да/не]	Bomba de calor agua-agua: [sí/no]	Teplné čerpadlo voda-voda: [ano/ne]
D	Brine-to-water heat pump: [yes/no]	Термопомпа „солов разтвор-вода“: [да/не]	Bomba de calor salmuera-agua: [sí/no]	Teplné čerpadlo solanka-voda: [ano/ne]
E	Low-temperature heat pump: [yes/no]	Термопомпа за нискотемпературни приложения: [да/не]	Bomba de calor de baja temperatura: [sí/no]	Nizkoteplotní teplné čerpadlo: [ano/ne]
F	Equipped with a supplementary heater: [yes/no]	Оборудвана с допълнителен подгревател: [да/не]	Equipado con un calefactor complementario: [sí/no]	Vybavenost s přídatným ohřívačem: [ano/ne]
G	Heat pump combination heater: [yes/no]	Комбиниран термопомпен апарат за отопление и БВ: [да/не]	Calefactor combinado con bomba de calor: [sí/no]	Kombinovaný ohřívač s teplným čerpadlem: [ano/ne]
H	Parameters shall be declared for medium-temperature application, except for low-temperature heat pumps. For low-temperature heat pumps, parameters shall be declared for low-temperature application.	Параметрите се обявяват за среднотемпературни приложения, освен при термопомпите с нискотемпературни приложения. При термопомпите с нискотемпературни приложения параметрите се обявяват за нискотемпературните приложения.	Los parámetros se declararán para aplicaciones de media temperatura, excepto si se trata de bombas de calor de baja temperatura. En el caso de las bombas de calor de baja temperatura, los parámetros se declararán para aplicaciones de baja temperatura.	Parametry musí být uvedeny pro středněteplotní aplikaci, s výjimkou nízkoteplotních tepelných čerpadel. U nízkoteplotních tepelných čerpadel musí být parametry uvedeny pro nízkoteplotní aplikaci.
I	Parameters shall be declared for average climate conditions.	Параметрите се обявяват за средни климатични условия.	Los parámetros se indicarán para condiciones climáticas medias.	Parametry musí být uvedeny pro průměrné klimatické podmínky.
J	Item	Характеристика	Elemento	Položka
K	Symbol	Означение	Símbolo	Označení
L	Value	Стойност	Valor	Hodnota
M	Unit	Мерна единица	Unidad	Jednotka
N	Rated heat output(*)	Номинална топлинна мощност(*)	Potencia calorífica nominal (*)	Jmenovitý tepelný výkon (*)
O	Prated	Prated	Prated	Prated
P	Seasonal space heating energy efficiency	Сезонна енергийна ефективност при отопление	Eficiencia energética estacional de calefacción	Sezónní energetická účinnost vytápění
Q	Declared capacity for heating for part load at indoor temperature 20 °C and outdoor temperature Tj	Обявена отоплителна мощност за частичен товар при температура вътре 20 °C и външна температура Tj	Capacidad de calefacción declarada para una carga parcial a una temperatura interior de 20 °C y una temperatura exterior Tj	Deklarovaný topný výkon pro částečné zatížení při vnitřní teplotě 20 °C a venkovní teplotě Tj
R	Declared coefficient of performance or primary energy ratio for part load at indoor temperature 20 °C and outdoor temperature Tj	Обявен коефициент на трансформация или коефициент на първичната енергия за частичен товар при температура вътре 20 °C и външна температура Tj	Coefficiente de rendimiento declarado o factor energético primario para una carga parcial a una temperatura interior de 20 °C y una temperatura exterior Tj	Deklarovaný topný faktor či koeficient primární energie pro částečné zatížení při vnitřní teplotě 20 °C a venkovní teplotě Tj
S	COPd or PERd	COPd или PERd	COPd o PERd	COPd nebo PERd
T	Tj = bivalent temperature	Tj = температура на включване на допълнително подгреване	Tj = temperatura bivalente	Tj = bivalentní teplota
U	Tj = operation limit temperature	Tj = гранична работна температура	Tj = temperatura límite de funcionamiento	Tj = mezní provozní teplota
V	For air-to-water heat pumps: Tj = -15 °C (if TOL < -20 °C)	За термопомпи „въздух-вода“: Tj = -15 °C (ако TOL < -20 °C)	Para bombas de calor aire-agua: Tj = -15 °C (si TOL < -20 °C)	U tepelných čerpadel vzduch-voda: Tj = -15 °C (pokud TOL < -20 °C)
W	Bivalent temperature	Температура на включване на допълнително подгреване	Temperatura bivalente	Bivalentní teplota
X	For air-to-water heat pumps: Operation limit temperature	За термопомпи „въздух-вода“: гранична работна температура	Para bombas de calor aire-agua: Temperatura límite de funcionamiento	U tepelných čerpadel vzduch-voda: mezní provozní teplota
Y	Cycling interval capacity for heating	Мощност при повторно-кратковременен режим на отопление	Eficiencia del intervalo cíclico para calefacción	Topný výkon v cyklickém intervalu
Z	Cycling interval efficiency	Ефективност при повторно-кратковременен режим	Eficiencia del intervalo cíclico	Účinnost v cyklickém intervalu
AA	COPcyc or PERcyc	COPcyc или PERcyc	COPcyc o PERcyc	COPcyc nebo PERcyc
AB	Degradation co-efficient(**)	Коефициент на влошаване на ефективността(**)	Coefficiente de degradación (**)	Koeficient ztráty energie (**)
AC	Heating water operating limit temperature	Гранична температура на загреваната вода	Temperatura límite de calentamiento de agua	Mezní provozní teplota ohříváné vody

No	English(EN)	Bulgarian(BG)	Spanish(ES)	Czech(CS)
AD	Power consumption in modes other than active mode	Консумирана мощност в режими, различни от работен режим	Consumo de electricidad en modos distintos del activo	Spotřeba elektrické energie v jiných režimech než aktivní režim
AE	Supplementary heater	Допълнителен подгревател	Calefactor complementario	Přídavný ohřívač
AF	Off mode	Режим „изключен“	Modo desactivado	Vypnutý stav
AG	Thermostat-off mode	Режим „термостатно изключен“	Modo desactivado por termostato	Stav vypnutého termostatu
AH	Standby mode	Режим „в готовност“	Modo de espera	Pohotovostní režim
AI	Crankcase heater mode	Режим „подгриване на картера на компресора“	Modo de calentador del cárter	Režim zahřívání skříně kompresoru
AJ	Type of energy input	Вид на постъпващата енергия	Tipo de insumo de energía	Energetický příkon
AK	Other items	Други характеристики	Otros elementos	Jiné položky
AL	Capacity control	Регулиране на мощността	Control de capacidad	Regulace výkonu
AM	fixed/variable	фиксирана/регулируема	fijo/variable	pevná/proměnná
AN	For air-to-water heat pumps: Rated air flow rate, outdoors	За термопомпи „въздух-вода“: номинален дебит на въздуха (на открито)	Para bombas de calor aire-agua: Caudal de aire nominal (exterior)	U tepelných čerpadel vzduch-voda: jmenovitý průtok vzduchu ve venkovním prostoru
AO	m ³ /h	m ³ /h	m ³ /h	m ³ /h
AP	Sound power level, indoors/outdoors	Ниво на шума (вътре/на открито)	Nivel de potencia acústica (interior/exterior)	Hladina akustického výkonu ve vnitřním prostoru/venkovním prostoru
AQ	Emissions of nitrogen oxides	Емисии на азотни окиси	Emisiones de óxidos de nitrógeno	Emise oxidů dusíku
AR	For water-/brine-to-water heat pumps: Rated brine or water flow rate, outdoor heat exchanger	За термопомпи „вода/сопов разтвор-вода“: номинален дебит на соловия разтвор, или водата, външен теплообменник	Para bombas de calor agua/salmuera a agua: Caudal de salmuera o de agua nominal, intercambiador de calor de exterior	U tepelných čerpadel voda-voda/solanka-voda: jmenovitý průtok solanky nebo vody, venkovní výměník tepla
AS	For heat pump combination heater:	За комбиниран термомпен агрегат за отопление и БГБ:	Para calefactores combinados con bomba de calor:	U kombinovaného ohřivače s tepelným čerpadlem:
AT	Declared load profile	Обявен товаров профил	Perfil de carga declarado	Deklarovaný zátěžový profil
AU	Water heating energy efficiency	Енергийна ефективност при подгриване на вода	Eficiencia energética de caldeo de agua	Energetická účinnost ohřevu vody
AV	Daily electricity consumption	Дневно електропотребление	Consumo diario de electricidad	Denní spotřeba elektrické energie
AW	Daily fuel consumption	Дневно потребление на гориво	Consumo diario de combustible	Denní spotřeba paliva
AX	Contact details	Координати за връзка	Datos de contacto	Kontaktní údaje
AY	(*) For heat pump space heaters and heat pump combination heaters, the rated that output Prated is equal to the design load for heating Pdesignh, and the rated heat output of a supplementary heater Psup is equal to the supplementary capacity for heating sup(Tj).	(*) За отоплителни термомпени агрегати и комбиниран термомпен агрегат, номиналната топлинна мощност Prated е равна на проектния отоплителен товар Pdesignh, а номиналната топлинна мощност на допълнителния подгревател Psup е равна на допълнителната отоплителна мощност sup(Tj)	(*) Para los aparatos de calefacción con bomba de calor y calefactores combinados con bomba de calor, la potencia calorífica nominal Prated es igual a la carga de calefacción de diseño Pdesignh, y la potencia calorífica nominal de un calefactor complementario Psup es igual a la capacidad complementaria de calefacción sup(Tj).	(*) U ohřivačů pro vytápění vnitřních prostorů s tepelným čerpadlem a kombinovaných ohřivačů s tepelným čerpadlem je jmenovitý tepelný výkon Prated roven návrhovému topnému zařízení Pdesignh a jmenovitý tepelný výkon přídavného ohřivače Psup je roven doplňkovému topnému výkonu sup(Tj).
AZ	(**) If Cdh is not determined by measurement then the default degradation coefficient is Cdh = 0.9.	(**) Ако Cdh не е определен чрез измерване, съответната ориентировъчно приемана стойност за коефициента на влошаване на ефективността е Cdh = 0,9.	(**) Si no se determina Cdh por medición, el coeficiente de degradación predeterminado será Cdh = 0,9.	(**) Není-li koeficient ztráty energie Cdh stanoven měřením, má implicitní hodnotu 0,9.
BA	1) Precautions as described in the installation/user manual must be taken when assembling, installing and maintaining this product.	1) Описаните в ръководството за монитране/ръководството за потребителя предпазни мерки трябва да се спазват при събиране, монитране и поддръжка на продукта.	1) Deben tomarse las precauciones que se indican en el manual de instalación/usuario al montar e instalar el producto, así como al realizar tareas de mantenimiento.	1) Při montáži, instalaci a údržbě tohoto produktu je třeba se řídit bezpečnostními opatřeními popsány v instalační a uživatelské příručce.
BB	2) If you are a professional looking for information on non-destructive disassembly and dismantling, please send an email to: erims.sec@samsung.com	2) Ако сте професионалист и търсите информация относно възможностите за неразрушително разглобяване и демонтаж, моля, изпратете имейл на адрес: erims.sec@samsung.com	2) Si Usted es un profesional que desea obtener información sobre el desmontaje y desmantelamiento no destructivo de este producto, por favor, diríjase a la siguiente dirección de correo electrónico: erims.sec@samsung.com	2) Pokud jste odborným pracovníkem a hledáte informace ohledně bezpečné demontáže produktu, napište e-mail na adresu: erims.sec@samsung.com.

COMMISSION REGULATION (EU) No 813/2013¹⁾

No	Danish(DA)	German(DE)	Estonian(ET)	Greek(EL)
I	KOMMISSIONENS FORORDNING (EU) Nr. 813/2013	VERORDNUNG (EU) Nr. 813/2013 DER KOMMISSION	KOMISJONI MÄÄRUS (EU) nr 813/2013,	ΚΑΝΟΝΙΣΜΟΣ (ΕΕ) αριθ. 813/2013 ΤΗΣ ΕΠΙΤΡΟΠΗΣ
II	Kravene til miljøvenligt design af anlæg til rumopvarmning	Die Ökodesign-Anforderungen an Raumheizgerät	Ökodesaini nõuded ruumi kütteseks	Οι απαιτήσεις οικολογικού σχεδιασμού για θερμαντήρας χώρου
A	Model(ler): [Information, som identificerer den eller de modeller, som oplysningerne vedrører]	Modell(e): (Angaben zur Bestimmung des Modells/der Modelle, auf das/die sich die Angaben beziehen)	Mudel(id): [mudelit (mudeleid) iseloomustavad näitajad]	Μοντέλο(α): [Πληροφορίες για την ταυτοποίηση του μοντέλου (των μοντέλων) που αφορούν οι πληροφορίες]
B	Luft-vand-varmepumpe: [ja/nej]	Luft-Wasser-Wärmepumpe: (Ja/Nein)	Õhu-vee-soojuspump: [jah/ei]	Αντλία θερμότητας αέρα-νερού: [ναυ/όχι]
C	Vand-vand-varmepumpe: [ja/nej]	Wasser-Wasser-Wärmepumpe: (Ja/Nein)	Vee-vee-soojuspump: [jah/ei]	Αντλία θερμότητας νερού-νερού: [ναυ/όχι]
D	Brine-vand-varmepumpe: [ja/nej]	Sole-Wasser-Wärmepumpe: (Ja/Nein)	Soojuskinda-vee-soojuspump: [jah/ei]	Αντλία θερμότητας αλμής-νερού: [ναυ/όχι]
E	Lavtemperaturvarmepumpe: [ja/nej]	Niedertemperatur-Wärmepumpe: (Ja/Nein)	Külma kliima soojuspump: [jah/ei]	Αντλία θερμότητας χαμηλής θερμοκρασίας: [ναυ/όχι]
F	Udstyret med supplerende forsyningsanlæg: [ja/nej]	Mit Zusatzheizgerät: (Ja/Nein)	Koos lisakütteseadmega: [jah/ei]	Εξοπλισμένος με συμπληρωματικό θερμαντήρα: [ναυ/όχι]
G	Varmepumpeanlæg til kombineret rum- og brugsvandsopvarmning: [ja/nej]	Kombiheizgerät mit Wärmepumpe: (Ja/Nein)	Soojuspumba vee-soojendi-küttesead:	Θερμαντήρας συνδυασμένης λειτουργίας με αντλία θερμότητας: [ναυ/όχι]
H	Parametre skal angives for middeltemperaturanvendelse, dog ikke for lavtemperaturvarmepumper. For lavtemperaturvarmepumper angives parametre for lavtemperaturanvendelse.	Die Parameter sind für eine Mitteltemperaturanwendung anzugeben, außer für Niedertemperatur-Wärmepumpen. Für Niedertemperatur-Wärmepumpen sind die Parameter für eine Niedertemperaturanwendung anzugeben.	Näitajad esitatakse keskmise temperatuuriga kasutuse kohta, välja arvatud külma kliima soojuspumbad. Külma kliima soojuspumpade näitajad esitatakse madaltemperatuurilise kasutuse kohta.	Δηλώνονται οι παράμετροι για εφαρμογή μέσης θερμοκρασίας, εξαιρουμένων των αντλιών θερμότητας χαμηλής θερμοκρασίας. Για τις αντλίες θερμότητας χαμηλής θερμοκρασίας δηλώνονται οι παράμετροι για εφαρμογή χαμηλής θερμοκρασίας.
I	Parametre skal angives for gennemsnitlige klimaforhold.	Die Parameter sind für durchschnittliche Klimaverhältnisse anzugeben:	Näitajad esitatakse keskmiste kliimatingimuste kohta.	Δηλώνονται οι παράμετροι για μέσες κλιματικές συνθήκες.
J	Element	Angabe	Näitaja	Χαρακτηριστικό
K	Symbol	Symbol	Tähis	Σύμβολο
L	Værdi	Wert	Väärtus	Τιμή
M	Enhed	Einheit	Ühik	Μονάδα
N	Nominel nytteeffekt (*)	Wärmennleistung (3)	Nimisoojusvõimsus (*)	Ονομαστική θερμική ισχύς (*)
O	Prated	Prated	Prated	Prated
P	Årsvirkningsgrad ved rumopvarmning	Jahreszeitbedingte Raumheizungs-Energieeffizienz	Kütmise sesoonne energiätõhusus	Ενεργειακή απόδοση της εποχιακής θέρμανσης χώρου
Q	Angivet varmedyelse for dellast ved indetemperatur på 20 °C og udetemperatur på Tj	Angegebene Leistung für Teillast bei Raumlufttemperatur 20 °C und Außenlufttemperatur Tj	Esitatud soojusvõimsus ruumitemperatuurile 20 °C ja välitemperatuurile Tj vastaval (osalise koormuse) võimsustarbel	Δηλωμένη θερμαντική ισχύς για μερικό φορτίο σε θερμοκρασία εσωτερικού χώρου 20 °C και θερμοκρασία εξωτερικού χώρου Tj
R	Angivet effektfaktor eller primærenergi-effektfaktor for dellast ved indetemperatur på 20 °C og udetemperatur på Tj	Angegebene Leistungszahl oder Heizzahl für Teillast bei Raumlufttemperatur 20 °C und Außenlufttemperatur Tj	Esitatud soojustegur (primaarenergiategur) ruumitemperatuurile 20 °C ja välitemperatuurile Tj vastaval (osalise koormuse) võimsustarbel	Δηλωμένος συντελεστής απόδοσης ή λόγος πρωτογενούς ενέργειας σε θερμοκρασία εσωτερικού χώρου 20 °C και θερμοκρασία εξωτερικού χώρου Tj
S	COPd eller PERd	COPd oder PERd	COPd või PERd	COPd ή PERd
T	Tj = bivalenttemperatur	Tj = Bivalenttemperatur	Tj = tasakaaltemperatuur	Tj = δίπτυχη θερμοκρασία
U	Tj = temperaturgrense for drift	Tj = Betriebstemperturgrenzwert	Tj = piirtootemperatuur	Tj = οριακή θερμοκρασία λειτουργίας
V	For luft-vand-varmepumper: Tj = - 15 °C (hvis TOL < - 20 °C)	Für Luft-Wasser-Wärmepumpen: Tj = - 15 °C (wenn TOL < - 20 °C)	Õhu-vee-soojuspump: Tj = - 15 °C (kui TOL < - 20 °C)	Για αντλίες θερμότητας αέρα-νερού: Tj = - 15 °C (εάν TOL < - 20 °C)
W	Bivalenttemperatur	Bivalenttemperatur	Tasakaaltemperatuur	Δίπτυχη θερμοκρασία
X	For luft-vand-varmepumper: Temperaturgrense for drift	Für Luft-Wasser-Wärmepumpen: Betriebsgrenzwert-Temperatur	Õhu-vee-soojuspump: piirtootemperatuur	Για αντλίες θερμότητας αέρα-νερού: Οριακή θερμοκρασία λειτουργίας
Y	Cykusintervalydelse for opvarmning	Leistung bei zyklischem Intervall-Heizbetrieb	Tsükli soojusvõimsus	Θερμαντική ισχύς κατά τη διάρκεια ενός κύκλου
Z	Cykusintervalydelse	Leistungszahl bei zyklischem Intervallbetrieb	Tsükli tõhusus või primaarenergiategur	Απόδοση κατά τη διάρκεια ενός κύκλου
AA	COPcyc eller PERcyc	COPcyc oder PERcyc	COPcyc või PERcyc	COPcyc ή PERcyc
AB	Koefficient for effektivitetstab (**)	Minderungsfaktor (4)	Kaotegur (**)	Συντελεστής υποβάθμισης (**)
AC	Temperaturgrense for vandopvarmning	Grenzwert der Betriebstemperatur des Heizwassers	Küttevee piirtootemperatuur	Οριακή θερμοκρασία λειτουργίας για θέρμανση νερού
AD	Elforbrug i andre tilstand end aktiv tilstand	Stromverbrauch in anderen Betriebsarten als dem Betriebszustand	Võimsustarve ajal, kui seade ei ole aktiivses seisundis	Κατανάλωση ισχύος σε καταστάσεις πλνν της ενεργού κατάστασης
AE	Supplerende forsyningsanlæg	Zusatzheizgerät	Lisaküttesead	Συμπληρωματικός θερμαντήρας

No	Danish(DA)	German(DE)	Estonian(ET)	Greek(EL)
AF	Slukket tilstand	Aus-Zustand	Väljalülitatud seisund	Κατάσταση εκτός λειτουργίας
AG	Termostat fra-tilstand	Thermostat-aus-Zustand	Termostaadiga välja lülitatud seisund	Κατάσταση χωρίς λειτουργία θερμοστάτη
AH	Standbytilstand	Bereitschaftszustand	Ooteseisund	Κατάσταση αναμονής
AI	Krumtaphusopvarmingstilstand	Betriebszustand mit Kurbelgehäuseheizung	Kambrikütte seisund	Λειτουργία θερμοαντλία στροφοθαλάμιου
AJ	Energipiuttype	Art der Energiezufuhr	Sisendenergia liik	Τύπος εισερχόμενης ενέργειας
AK	Andre elementer	Sonstige Angaben	Muud näitajad	Άλλα χαρακτηριστικά
AL	Ydelsesregulering	Leistungssteuerung	Võimsuse reguleerimine	Ρύθμιση ισχύος
AM	fast/variabel	fest/veränderlich	Muutumatul/muudetak	σταθερή/μεταβλητή
AN	For luft-vand-varmepumper: Nominel luftgennemstrømning, ude	Für Luft-Wasser-Wärmepumpen: Nenn-Luftdurchsatz, außen	Õhu-vee-soojuspump: õhu niimivooluhulk, väliskeskkonnas	Για αντλίες θερμότητας αέρα-νερού: Ονομαστική παροχή αέρα, εξωτερικού χώρου
AO	m ³ /h	m ³ /h	m ³ /h	m ³ /h
AP	Lydeffektniveau, inde/ude	Schalleistungspegel, innen/außen	Müravõimsustase, siseruumis/väliskeskkonnas	Στάθμη ηχητικής ισχύος, εσωτερικού/ εξωτερικού χώρου
AQ	Emissioner af kvælstofilter	Stickoxidaustoß	Lämmastikoksiidide heide	Εκπομπές οξειδίου του αζώτου
AR	For vand/brine-vand-varmepumper: nominel brine- eller vandgennemstrømning, varmeveksler, ude	Für Wasser/Sole-Wasser-Wärmepumpen: Wasser- oder Sole-Nenndurchsatz	Vee-soojuskandja-vee-soojuspump: soojuskandja või vee niimivooluhulk, soojusvaheti väljas	Για αντλίες θερμότητας νερού-/άλης-νερού: Ονομαστική παροχή άλης ή νερού, εναλλάκτη θερμότητας εξωτερικού χώρου
AS	For varmepumpeanlæg til kombineret rum- og brugsvarmepumpe	Kombiheizgerät mit Wärmepumpe	Soojuspumbaga veesoojendi-kütteseadede	Για θερμοαντλία συνδυασμένης λειτουργίας με αντλία θερμότητας
AT	Angivet forbrugsprofil	Angegebenes Lastprofil	Estatud koormusprofiil	Δηλωμένο προφίλ φορτίου
AU	Energieeffektivitet ved vandopvarmning	Warmwasserbereitungs-Energieeffizienz	Vee soojendamise kasutegur	Ενεργειακή απόδοση θέρμανσης νερού
AV	Dagligt elforbrug	Täglicher Stromverbrauch	Päevane elektrienergiatarve	Ημερήσια κατανάλωση ηλεκτρικής ενέργειας
AW	Dagligt brændselsforbrug	Täglicher Brennstoffverbrauch	Päevane kütteenegiatarve	Ημερήσια κατανάλωση καυσίμου
AX	Kontaktoplysninger	Kontakt	Kontaktandmed	Στοιχεία επικοινωνίας
AY	(*) For varmepumpeanlæg til rumopvarmning og varmepumpeanlæg til kombineret rum- og brugsvarmepumpe er den nominelle nytteeffekt Prated lig med den dimensionerende last for opvarmning Pdesignh, og den nominelle nytteeffekt for et supplerende forsyningsanlæg Psup er lig med den supplerende varmefydelse sup(Tj).	(*) Für Heizgeräte und Kombiheizgeräte mit Wärmepumpe ist die Wärmenennleistung Prated gleich der Auslegungslast im Heizbetrieb Pdesignh und die Wärmenennleistung eines Zusatzheizgerätes Psup gleich der zusätzlichen Heizleistung sup(Tj).	(*) Soojuspumbaga kütteseadmete ja soojuspumbaga veesoojendite-kütteseadmete niimisoovõimsus Prated on võrdne arvutusliku soojusvõimsusega Pdesignh, lisakütteseadmete Psup niimisoovõimsus on võrdne lisakütteseadmete soojusvõimsusega sup(Tj).	(*) Για θερμοαντλίες χώρου με αντλία θερμότητας και θερμοαντλίες συνδυασμένης λειτουργίας με αντλία θερμότητας, η ονομαστική θερμική ισχύς Prated ισούται με το θερμοαντικό φορτίο σχεδιασμού Pdesignh, και η ονομαστική θερμική ισχύς του συμπληρωματικού θερμοαντλία Psup ισούται με τη συμπληρωματική θερμοαντική ισχύ sup(Tj).
AZ	(**) Hvis Cdh ikke bestemmes ved måling, er koeficienten for effektivitetstab som standard Cdh = 0,9.	(**) Wird der Cdh-Wert nicht durch Messung bestimmt, gilt für den Minderungsfaktor der Vorgabewert Cdh = 0,9.	(**) Kui tegur Cdh on määratama, võetakse vaikimisi Cdh = 0,9.	(**) Εάν ο Cdh δεν προσδιοριστεί με μέτρηση, ο εξ ορισμού συντελεστής υποβάθμισης είναι Cdh = 0,9.
BA	1) Du skal tage de forholdsregler, der er beskrevet i installations-/brugervejledningen, når du samler, installerer og vedligeholder dette produkt.	1) Beim Montieren, Installieren und Warten des Geräts müssen die im Installations-/ Benutzerhandbuch beschriebenen Vorsichtsmaßnahmen eingehalten werden.	1) Seadme kokkupanekul, paigaldamisel ja hooldusel tuleb rakendada paigaldus-/kasutusjuhendis kirjeldatud ettevaatusabinõusid	1) Όταν συναρμολογείτε, εγκαθιστάτε και συντηρείτε αυτό το προϊόν, πρέπει να λαμβάνετε τις προφυλάξεις που περιγράφονται στο εγχειρίδιο εγκατάστασης/χρήσης.
BB	2) Hvis du er en erhvervsdrivende, der søger information om, hvordan man afmonterer støvsugeren uden at ødelægge nogle dele, bedes du sende en e-mail til: erims.sec@samsung.com	2) Wenn Sie als Fachkraft Informationen zu zerstörungsfreier Demontage und Zerlegung benötigen, schreiben Sie bitte eine E-Mail an: erims.sec@samsung.com.	2) Kui olete professionaal, kes otsib teavet mittekahjustava lahtivõtmise ja demonteerimise kohta, saate palun e-kiri aadressil: erims.sec@samsung.com.	2) Εάν είστε επαγγελματίας και αναζητάτε πληροφορίες σχετικά με την αποσυναρμολόγηση χωρίς να προκληθούν καταστροφές, στείλετε μήνυμα ηλεκτρονικού ταχυδρομείου στη διεύθυνση: erims.sec@samsung.com

COMMISSION REGULATION (EU) No 813/2013 ¹⁾

No	French(FR)	Croatian(HR)	Italian(IT)	Latvian(LV)
I	RÈGLEMENT (UE) No 813/2013 DE LA COMMISSION	UREDBA KOMISIJE (EU) br. 813/2013	REGOLAMENTO (UE) N. 813/2013 DELLA COMMISSIONE	KOMISIJAS REGULA (ES) Nr. 813/2013
II	Les exigences d'écoconception applicables aux dispositifs de chauffage des locaux	Zahtjevi za ekološki dizajn grijač prostora	Le specifiche per la progettazione ecocompatibile per apparecchio il riscaldamento d'ambiente	Ekodizaina prasības par telpu sildītājs
A	Modèle(s); [informations d'identification du ou des modèles concernés]	Model(i); [informacije za identifikaciju modela na koji(-e) se informacije odnose]	Modelli; [Informazioni per identificare i modelli cui sono riferibili le informazioni]	Modelis(-i); [informācija, ar ko identificē model(-)us], uz kuru(-iem) informācija attiecas]
B	Pompes à chaleur air-eau; [oui/non]	Toplinska crpka zrak-voda; [da/ne]	Pompa di calore aria/acqua; [si/no]	Gaiss-ūdens siltumsūkņis; [jā/nē]
C	Pompes à chaleur eau-eau; [oui/non]	Toplinska crpka voda-voda; [da/ne]	Pompa di calore acqua/acqua; [si/no]	Ūdens-ūdens siltumsūkņis; [jā/nē]
D	Pompe à chaleur eau glycolée-eau; [oui/non]	Toplinska crpka slana voda-voda; [da/ne]	Pompa di calore salamoia/acqua; [si/no]	Sālsūdens-ūdens siltumsūkņis; [jā/nē]
E	Pompes à chaleur basse température; [oui/non]	Niskotemperatūra toplinska crpka; [da/ne]	Pompa di calore a bassa temperatura; [si/no]	Zemas temperatūras diapazona siltumsūkņis; [jā/nē]
F	Équipée d'un dispositif de chauffage d'appoint; [oui/non]	Opremljena dodatnim grijačem; [da/ne]	Con riscaldatore supplementare; [si/no]	Apriekš ar papildu sildītāju; [jā/nē]
G	Dispositif de chauffage mixte par pompe à chaleur; [oui/non]	Kombinirani grijači s toplinskom crpkom; [da/ne]	Apparecchio misto a pompa di calore; [si/no]	Siltumsūkņa kombinētais sildītājs; [jā/nē]
H	Les paramètres sont déclarés pour l'application à moyenne température, excepté pour les pompes à chaleur basse température. Pour les pompes à chaleur basse température, les paramètres sont déclarés pour l'application à basse température.	Parametri se navode za uporabu pri srednjoj temperaturi, osim za niskotemperaturne toplinske crpkas. Za niskotemperaturne toplinske crpkas parametri se navode za uporabu pri niskoj temperaturi.	I parametri sono dichiarati per l'applicazione a temperatura media, tranne per le pompe di calore a bassa temperatura. Per le pompe di calore a bassa temperatura, i parametri sono dichiarati per l'applicazione a bassa temperatura.	Parametrus deklarē izmantošanai vidējas temperatūras diapazonā, izņemot zemas temperatūras diapazona siltumsūkņiem. Zemas temperatūras diapazona siltumsūkņiem parametri deklarē izmantošanai zemas temperatūras diapazonā.
I	Les paramètres sont déclarés pour les conditions climatiques moyennes.	Parametri se navode za prosječne klimatske uvjete.	I parametri sono dichiarati per condizioni climatiche medie.	Parametrus deklarē vidējiem klimatiskajiem apstākļiem.
J	Caractéristique	Stavka	Elemento	Pozīcija
K	Symbole	Oznaka	Simbolo	Apzīmējums
L	Valeur	Vrijednost	Valore	Vērtība
M	Unité	Jedinica	Unità	Vienība
N	Puissance thermique nominale (*)	Nazivna toplinska snaga (*)	Potenza termica nominale (*)	Nominālā siltuma jauda (*)
O	Prated	Prated	Pnominale	Prated
P	Efficacité énergétique saisonnière pour le chauffage des locaux	Sezonska energetska učinkovitost grijanja prostora	Efficienza energetica stagionale del riscaldamento d'ambiente	Telpu apsildes sezonas energoefektivitāte
Q	Puissance calorifique déclarée à charge partielle pour une température intérieure de 20 °C et une température extérieure Tj	Deklarirani ogrievni kapacitet za djelomično opterećenje pri unutarnjoj temperaturi od 20 °C i vanjskoj temperaturi Tj	Capacità di riscaldamento dichiarata a carico parziale, con temperatura interna pari a 20 °C e temperatura esterna Tj	Deklarētā jauda sildīšanai pie daļējas slodzes, ja temperatūra telpā ir 20 °C un ārējais temperatūra ir Tj
R	Coefficient de performance déclaré ou coefficient sur énergie primaire déclaré à charge partielle pour une température intérieure de 20 °C et une température extérieure Tj	Deklarirani koeficient učinkovitosti ili omjer primarne energije za djelomično opterećenje pri unutarnjoj temperaturi od 20 °C i vanjskoj temperaturi Tj	Coefficiente di prestazione dichiarato o indice di energia primaria per carico parziale, con temperatura interna pari a 20 °C e temperatura esterna Tj	Deklarētais lietderības koeficients vai primārās enerģijas patēriņa rādītājs pie daļējas slodzes, ja temperatūra telpā ir 20 °C un ārējais temperatūra ir Tj
S	COPd ou PERd	COPd ili PERd	COPd oppure PERd	COPd vai PERd
T	Tj = température bivalente	Tj = bivalentna temperatura	Tj = temperatura bivalente	Tj = bivalentā temperatūra
U	Tj = température limite de fonctionnement	Tj = grānīcna radna temperatura	Tj = temperatura limite di esercizio	Tj = darba režīma robežtemperatūra
V	Pour les pompes à chaleur air-eau: Tj = -15 °C (si TOL < -20 °C)	Za toplinske crpkas zrak-voda: Tj = -15 °C (ako je TOL < -20 °C)	Per le pompe di calore aria/acqua: Tj = -15 °C (se TOL < -20 °C)	Gaiss-ūdens siltumsūkņiem: Tj = -15 °C (ja TOL < -20 °C)
W	Température bivalente	Bivalentna temperatura	Temperatura bivalente	Bivalentā temperatūra
X	Pour les pompes à chaleur air-eau: température limite de fonctionnement	Za toplinske crpkas zrak-voda: Grānīcna radna temperatura	Per le pompe di calore aria/acqua: temperatura limite di esercizio	Gaiss-ūdens siltumsūkņiem: darba režīma robežtemperatūra
Y	Puissance calorifique sur un intervalle cyclique	Ogrievni kapacitet intervala ciklusa	Ciclicità degli intervalli di capacità per il riscaldamento	Cikliskā intervāla jauda sildīšanai
Z	Efficacité sur un intervalle cyclique	Učinkovitost intervala ciklusa	Efficienza della ciclicità degli intervalli	Cikliskā intervāla efektivitāte
AA	COPcyc ou PERcyc	COPcyc ili PERcyc	COPcyc oppure PERcyc	COPcyc vai PERcyc
AB	Coefficient de dégradation (**)	Koeficient degradacije (**)	Coefficiente di degradazione (**)	Pazeminājuma koeficients (**)
AC	Température maximale de service de l'eau de chauffage	Grānīcna radna temperatura za grijanje vode	Temperatura limite di esercizio di riscaldamento dell'acqua	Ūdens uzsildīšanas darba režīma robežtemperatūra

No	French(FR)	Croatian(HR)	Italian(IT)	Latvian(LV)
AD	Consommation d'électricité dans les modes autres que le mode actif	Potrošnja energije u načinima koji ne uključuju aktivni način rada	Consumo energetico in modi diversi dal modo attivo	Jauda režīms, kas nav darba režīms
AE	Dispositif de chauffage d'appoint	Dodatni grijač	Riscaldatore supplementare	Papildu sildītājs
AF	Mode arrêt	Stanje isključenosti	Modo spento	Izslēgts režīms
AG	Mode arrêt par thermostat	Stanje isključenosti termostata	Modo termostato spento	Izslēgta termostata režīms
AH	Mode veille	Stanje mirovanja	Modo stand-by	Gaidstāves režīms
AI	Mode résistance de carter active	Način rada grijača kućišta	Modo riscaldamento del carter	Kartera sildītāja režīms
AJ	Type d'énergie utilisée	Vrsta utrošene energije	Tipo di alimentazione energetica	Pievadītās enerģijas veids
AK	Autres caractéristiques	Druge stavke	Altri elementi	Citas pozīcijas
AL	Régulation de la puissance	Upravljanje kapacitetom	Controllo della capacità	Jaudas regulēšana
AM	fixe/variable	fiksno/promjenljivo	fisso/variabile	fiksēta/maināma jauda
AN	Pour les pompes à chaleur air-eau: débit d'air nominal, à l'extérieur	Za toplinsku crpku zrak-voda: Nazivna stopa protoka zraka, na otvorenom	Per le pompe di calore aria/acqua: portata d'aria, all'esterno	Gaiss-ūdens siltumsūkņiem: nominālā gaisa caurplūde, ārpus telpām
AO	m ³ /h	m ³ /h	m ³ /h	m ³ /h
AP	Niveau de puissance acoustique, à l'intérieur/à l'extérieur	Razina zvučne snage, unutra/vani	Livello della potenza sonora, all'interno/all'esterno	Akustiskās jaudas līmenis telpās/ārpus telpām
AQ	Émissions d'oxydes d'azote	Emisija duškovog oksida	Emissioni di ossidi di azoto	Sļāpekļa oksīdu emisijas
AR	Pour les pompes à chaleur eau-eau ou eau glycolée-eau: débit nominal d'eau glycolée ou d'eau, échangeur thermique extérieur	Za toplinske crpke voda/slana voda-voda: Nazivna stopa protoka slane vode ili vode, na vanjskom izmjenjivaču topline	Per le pompe di calore acqua/acqua e salamoia/acqua: flusso di salamoia o acqua nominale, scambiatore di calore all'esterno	Ūdens vai sālsūdens-ūdens siltumsūkņiem: nominālā sālsūdens vai ūdens caurplūde, ārpus siltummaiņiem
AS	Pour les dispositifs de chauffage mixtes par pompe à chaleur:	Za kombinirane grijačs s toplinskom crpkom:	Per gli apparecchi di riscaldamento misti a pompa di calore:	Siltumsūkņa kombinētajam sildītājam:
AT	Profil de soutirage déclaré	Deklarirani profil opterećenja	Profilo di carico dichiarato	Deklarētais slodzes profils
AU	Efficacité énergétique pour le chauffage de l'eau	Enerģetiska učinkovitost zagrijavanja vode	Efficienza energetica di riscaldamento dell'acqua	Ūdens uzsildīšanas energoefektivitāte
AV	Consommation journalière d'électricité	Dnevna potrošnja elektrīcne energije	Consumo quotidiano di energia elettrica	Dienas elektroenerģijas patēriņš
AW	Consommation journalière de combustible	Dnevna potrošnja goriva	Consumo quotidiano di combustibile	Dienas kurināmā patēriņš
AX	Coordonnées de contact	Podaci za kontakt	Recapiti	Kontaktf informācija
AY	(*) Pour les dispositifs de chauffage des locaux par pompe à chaleur et les dispositifs de chauffage mixtes par pompe à chaleur, la puissance thermique nominale Prated est égale à la charge calorifique nominale Pdesignh et la puissance thermique nominale d'un dispositif de chauffage d'appoint Pspup est égale à la puissance calorifique d'appoint sup(Tj).	(*) Za toplinske crpke za grijanje prostora i kombinirane grijače s toplinskom crpkom nazivna toplinska snaga Prated jednaka je projektnom ogrijevnom opterećenju Pdesignh, a nazivna toplinska snaga dodatnog grijača Pspup jednaka je dodatnom ogrijevnom kapacitetu sup(Tj).	(*) Per gli apparecchi a pompa di calore per il riscaldamento d'ambiente e gli apparecchi di riscaldamento misti a pompa di calore, la potenza termica nominale Pnominale è pari al carico teorico per il riscaldamento Pdesignh e la potenza termica nominale di un riscaldatore supplementare Pspup è pari alla capacità supplementare di riscaldamento sup(Tj).	(*) Siltumsūkņa telpu sildītājum un siltumsūkņa kombinētajiem sildītājiem nominālā siltuma jauda Prated ir vienāda ar aprēķina slodzi sildīšanai Pdesignh un papildu sildītāja nominālā siltuma jauda Pspup ir vienāda ar sildīšanas papildu jaudu sup(Tj).
AZ	(**) Si le Cdh n'est pas déterminé par des mesures, le coefficient de dégradation par défaut est Cdh = 0,9.	(**) Ako Cdh nije određen mjerenjem, standardni koeficijent degradacije je Cdh = 0,9.	(**) Se Cdh non è determinato mediante misurazione, il coefficiente di degradazione è Cdh = 0,9.	(**) Ja Cdh nenosaka, izmantojot mērījumus, tad standarta pazeminājuma koeficients ir Cdh = 0,9.
BA	1) Des précautions, comme décrit dans le manuel d'installation/d'utilisation, doivent être prises lors du montage, de l'installation et de l'entretien de l'appareil.	1) Prilikom sastavljanja, instalacije i održavanja proizvoda potrebno je poduzeti mjere opreza navedene u priručniku za instalaciju / korisničkom priručniku.	1) Durante l'assiemeaggio, l'installazione e la manutenzione di questo apparecchio vanno poste in atto tutte le avvertenze e le precauzioni che sono indicate nei manuali di installazione e per l'utente.	1) Montāžas a produkta apkope jāveic saskaņā ar montāžas/lietošanas instrukciju.
BB	2) Si vous êtes un professionnel à la recherche des informations sur le démontage et le démantèlement, veuillez envoyer un e-mail à l'adresse: erims.sec@samsung.com	2) Ako ste stručnjak u potrazi za informacijama o nerazornom rastavljanju i rasklapanju, pošaljite elektroničku poruku na adresu: erims.sec@samsung.com	2) Se sei un tecnico e vuoi sapere come smontare in modo accurato e non distruttivo il prodotto, invia una email all'indirizzo: erims.sec@samsung.com	2) Ja esat meistars, kas meklē informāciju, kā demontēt un izjaukt ierīci, to nesabojojot, sūtiet e-pasta vēstuli uz adresi: erims.sec@samsung.com.

COMMISSION REGULATION (EU) No 813/2013¹⁾

No	Lithuanian(LT)	Hungarian(HU)	Maltese(MT)	Dutch(NL)
I	KOMISIJOS REGLAMENTAS (ES) Nr. 813/2013	A BIZOTTSÁG 813/2013/EU RENDELETE	REGOLAMENT TAL-KUMMISSJONI (UE) Nru 813/2013	VERORDENING (EU) Nr. 813/2013 VAN DE COMMISSIE
II	Ekologinio projektavimo reikalavimai už patalpų šildytuvus	A környezettudatos tervezésére vonatkozó követelményeket helyiségfűtő berendezés	Rekwiziti tal-ekolożinn għall hiter tal-post	De eisen inzake ecologisch ontwerp voor ruimteverwarmingstoelstel
A	Modelis (-iai) [modelio (-ų), kuriam (-iems) taikoma informacija, identifikavimo duomenys]	Modell(ek): [az információk tárgyát képező modell(ek) megjelölése]	Mudell(i): [tagħrif li bih jiġi identifikat il-mudell/jiġu identifikati l-mudelli li magħhom huwa relatat dan it-tagħrif]	Model(len): [informatie ter bepaling van het model waarop de informatie betrekking heeft]
B	Oro-vandens šilumos siurblys [taip / ne]	Levegő-víz típusú hőszivattyú: [igen/nem]	Pompa tas-shana arja-ilma: [iva/le]	Lucht/water-warmtepomp: [ja/nee]
C	Vandens-vandens šilumos siurblys [taip / ne]	Víz-víz típusú hőszivattyú: [igen/nem]	Pompa tas-shana ilma-ilma: [iva/le]	Water/water-warmtepomp: [ja/nee]
D	Tirpalo-vandens šilumos siurblys [taip / ne]	Sós víz-víz típusú hőszivattyú: [igen/nem]	Pompa tas-shana salmura-ilma: [iva/le]	Pekel/water-warmtepomp: [ja/nee]
E	Žematemperatūris šilumos siurblys [taip / ne]	Alacsony hőmérsékletű hőszivattyú: [igen/nem]	Pompa tas-shana b'temperatura baxxa: [iva/le]	Lagetemperatuurwarmtepomp: [ja/nee]
F	Ar yra papildomas šildytuvus [taip / ne]	Rendelkezik-e kiegészítő fűtőberendezéssel: [igen/nem]	Mgħammar b'hitir supplementari: [iva/le]	Uitgerust met aanvullend verwarmingstoelstel: [ja/nee]
G	Kombinuotasis šildytuvus su šilumos siurbliu [taip / ne]	Hőszivattyús kombinált fűtőberendezés: [igen/nem]	Hitir ikkombinat b'pompa tas-shana: [iva/le]	Combinatiewarmtepompstoelstel met warmtepomp: [ja/nee]
H	Pateikiami naudojimo esant vidutinei temperatūrai parametrai, išskyrus atvejus, kai teikiama informacija apie žematemperatūris šilumos siurblius. Žematemperatūris šilumos siurblių atvejui pateikiami naudojimo esant žemai temperatūrai parametrai.	A paramétereket az alacsony hőmérsékletű hőszivattyúk kivételével a közepes hőmérsékletű használatra vonatkozóan kell megadni. Az alacsony hőmérsékletű hőszivattyúk esetében a paramétereket az alacsony hőmérsékletű használatra vonatkozóan kell megadni.	Il-parametri għandhom jingħataw għal applikazzjoni b'temperatura medja, hliief għall-pompi tas-shana b'temperatura baxxa. Għall-pompi tas-shana b'temperatura baxxa, il-parametri għandhom jingħataw għal applikazzjoni b'temperatura baxxa.	Parameters moeten worden opgegeven voor toepassing op middelgrote temperatuur; uitgezonderd voor lagetemperatuurwarmtepompen. Voor lagetemperatuurwarmtepompen moeten parameters worden opgegeven bij toepassing op lage temperatuur.
I	Pateikiami naudojimo vidutinėmis klimato sąlygomis parametrai.	A paramétereket az átlagos éghajlati viszonyokra vonatkozóan kell megadni.	Il-parametri għandhom jingħataw għall-kundzjinnjejt klimatit medji.	Parameters moeten worden opgegeven voor gemiddelde klimaatomstandigheden.
J	Parametras	Elem	Fattur	Kenmerk
K	Sutartinis ženklas	Jel	Simbolu	Symbol
L	Vertė	Érték	Valur	Waarde
M	Vienetai	Mértékegység	Unità	Eenheid
N	Vardinis šilumos atidavimas (*)	Mért hőteljesítmény (*)	Potenza termika nominali (*)	Nominale warmteafgifte (*)
O	Prated	Prated	Prated	Prated
P	Sezoninis energijos patalpoms šildyti vartojimo efektyvumas	Szezonális helyiségfűtési hatásfok	Effiċjenza enerġetika staġjonali tat-tiшин tal-post	Seizoensgebonden energie-efficiëntie van ruimteverwarming
Q	Deklaruotasis šildymo pajėgumas su daline apkrova, esant 20 °C patalpų temperatūrai ir lauko temperatūrai Tj.	Nėvogęs fűtőteljesítmény részterhelés mellett, 20 °C beltéri és Tj kültéri hőmérsékleten:	Kapacitá tat-tiшин iddikjarata għal tagħbija parzjali b'temperatura ta' g'ewwa ta' 20 °C u temperatura ta' barra ta' Tj	Opgegeven verwarmingsvermogen voor deellast bij een binnentemperatuur van 20 °C en een buitentemperatuur Tj
R	Deklaruotasis veiksmingumo koeficientas arba priminės energijos santykis su daline apkrova, esant 20 °C patalpų temperatūrai ir lauko temperatūrai Tj.	Nėvogęs fűtési jóságfok vagy primerenergia-hányados részterhelés mellett, 20 °C beltéri és Tj kültéri hőmérsékleten	Koeffiċjent iddikjarat tal-prestazzjoni jew proporzjon iddikjarat tal-enerġija primarja għal tagħbija parzjali b'temperatura ta' g'ewwa ta' 20 °C u temperatura ta' barra ta' Tj	Opgegeven prestatiecoëfficiënt of primaire-energie-verhouding voor deellast bij een binnentemperatuur van 20 °C en buitentemperatuur Tj
S	COPd arba PERd	COPd vagy PERd	COPd jew PERd	COPd or PERd
T	Tj = perėjimo į dvejopo šildymo režimą temperatūra	Tj = bivalens hőmérséklet	Tj = temperatura bivalenti	Tj = bivalente temperatuur
U	Tj = ribinė veikimo temperatūra	Tj = megengedett üzemi hőmérséklet	Tj = temperatura tal-limitu tat-thaddim	Tj = uiterste bedrijfstemperatuur
V	Oro-vandens šilumos siurblių atveju – Tj = –15 °C (jei TOL < –20 °C)	Levegő-víz típusú hőszivattyúk esetében: Tj = –15 °C (ha TOL < –20 °C)	Għall-pompi tas-shana arja-ilma: Tj = –15 °C (jekk TOL < –20 °C)	Voor lucht/water-warmtepompen: Tj = –15 °C (als TOL < –20 °C)
W	Pereėjimo į dvejopo šildymo režimą temperatūra	Bivalens hőmérséklet	Temperatura bivalenti	Bivalente temperatuur
X	Oro-vandens šilumos siurblių atveju – Ribinė veikimo temperatūra	Levegő-víz típusú hőszivattyúk esetében: Megengedett üzemi hőmérséklet	Għall-pompi tas-shana arja-ilma: Temperatura tal-limitu tat-thaddim	Voor lucht/water-warmtepompen: uiterste bedrijfstemperatuur
Y	Ciklinis pajėgumas šildymo režimu	Fűtési ciklusteljesítmény	Kapacitá tal-intervall cikliku għat-tiшин	Cyclisch-intervalvermogen voor verwarming
Z	Ciklinis efektyvumas	Ciklikus jóságfok	Effiċjenza tal-intervall cikliku	Cyclisch-intervallefficiëntie
AA	COPcyc arba PERcyc	COPcyc vagy PERcyc	COPcyc jew PERcyc	COPcyc or PERcyc
AB	Blogėjimo koeficientas (**)	Degradációs tényező (**)	Koeffiċjent ta' degradazzjoni (**)	Verliescoëfficiënt (**)
AC	Šildymo vandens ribinė veikimo temperatūra	Fűtővíz megengedett üzemi hőmérséklete	Temperatura limitu tat-thaddim għall-ilma tat-tiшин	Uiterste bedrijfstemperatuur van sanitair water

No	Lithuanian(LT)	Hungarian(HU)	Maltese(MT)	Dutch(NL)
AD	Vartojamoji galia ne aktyviaja veiksenai	Energiąfogyasztás a főfunkción kívüli üzemmódban	Konsum tal-enerġija fil-modalitajiet minbarra dik attiva	Elektriciteitsverbruik in andere standen dan de actieve modus
AE	Papildomas šildytuvas	Kiegészítő fűtőberendezés	Hiter supplementari	Aanvullend verwarmingstoestel
AF	Išjungties veiksenai	Kikapcsolt üzemmód	Modalità Mitfi	Uit-stand
AG	Termostato išjungties veiksenai	Termostát által kikapcsolt üzemmód	Modalità bit-termostat mitfi	Thermostaat-uit-stand
AH	Budejimo veiksenai	Készenléti üzemmód	Modalità Stennija	Stand-by-stand
AI	Karterio šildymo veiksenai	Forgattyúház-fűtési üzemmód	Modalità tal-hiter tal-kisi tal-krank	Carterverwarming-stand
AJ	Tiekiamos energijos rūšis	Energiabevitelje jellege	Tip ta' kontribut tal-enerġija	Soort energie-input
AK	Kiti parametrai	További elemek	oġġetti oħra	Andere kenmerken
AL	Pajėgumo valdymas	Teljesítményszabályozás	Kontroll tal-kapaċità	Vermogenscontrole
AM	pastovus/kintamas	rőgzített/állítható	fiiss/varjabbli	vast/variabel
AN	Oro-vandens šilumos siurbliu atveju – vardinis oro srautas (lauke)	Levegő-víz típusú hőszivattyúk esetében: Mért légátömegáram, kültéri	Ghall-pompi tas-shana arja-ilma: Rata nominali ta' fluss tal-arja fuq barra	Voor lucht/water-warmtepompen: nominaal luchtdebiet, buiten
AO	m ³ /h	m ³ /h	m ³ /h	m ³ /h
AP	Garso galios lygis (patalpoje/lauke)	Hangteljesítményszint, beltéri/kültéri	Livell ta' qawwa tal-hoss, fuq barra/fuq ġewwa	Geluidsvermogensniveau, binnen/buiten
AQ	Išmetamų azoto oksidų kiekis	Nitrogén-oxid-kibocsátás	Emissionijiet tal-ossidi tan-nitroġenu	Emissies van stikstofoxiden
AR	Vandens-vandens ir tirpalo-vandens šilumos siurbliu atveju – vardinis tirpalo arba vandens srautas (lauko šilumokaityje)	Víz-/sós víz-víz típusú hőszivattyúk esetében: Mért sósvíz- vagy vízáramlási sebesség, kültéri hőcserélővel	Ghall-pompi tas-shana ilma-/salmura-ilma: Rata nominali ta' fluss tal-ilma jew tas-salmura, skambjatur tas-shana li jkun jinsan fuq barra	Voor water/water- en pekel/water-warmtepompen: nominaal pekel- of waterdebiet, warmtewisselaar buiten
AS	Kombinuotojo šildytuvo su šilumos siurbliu atveju	Hőszivattyús kombinált fűtőberendezés esetében:	Ghall-hiters ikkombinati b'pompa tas-shana:	Voor combinatieverwarmingstoestellen met warmtepomp:
AT	Deklaruotasis apkrovos profilis	Néveges terhelési profil	Profil tat-tagħbija ddiġjarat	Opgegeven capaciteitsprofiel
AU	Enerģijos vandeniu šildyti vartojimo efektyvumas	Vizmeleģitėsi hatásfok	Effiċjenza enerġetika ta-taħsin tal-ilma	Energie-efficiëntie van waterverwarming
AV	Elektros energijos suvartojimas per parą	Napi villamosenergia-fogyasztás	Konsum ta' kuljum tal-elettriku	Dagelijks elektriciteitsverbruik
AW	Kuro suvartojimas per parą	Napi tüzelőanyag-fogyasztás	Konsum ta' kuljum tal-fjuwil	Dagelijks brandstofverbruik
AX	Kontaktiniai duomenys	Elérhetőség	Dettagli ta' kuntatt	Contactgegevens
AY	(*) Patalpų šildytuvų su šilumos siurbliu ir kombinuotųjų šildytuvų su šilumos siurbliu atveju vardinis šilumos atidavimas Prated lygus projekcinėi apkrovai šildymo režimu Pdesignh, o papildomo šildytuvo vardinis šilumos atidavimas Psup lygus papildomam šildymo pajėgumui sup(Tj).	(*) Hőszivattyús helyiségfűtő berendezések és hőszivattyús kombinált fűtőberendezések esetében a Prated mért hőteljesítmény egyenlő a Pdesignh tervezési fűtési terheléssel, emellett a kiegészítő fűtőberendezés Psup mért hőteljesítménye megegyezik a sup(Tj) kiegészítő fűtőteljesítménnyel.	(*) Ghall-hiters tal-post b'pompa tas-shana u ghall-hiters ikkombinati b'pompa tas-shana, il-potenza termika nominali, Prated, hija daqs it-tagħbija tad-disinjn għat-tishin, Pdesignh, u l-potenza termika nominali ta' hiter supplementari, Psup, hija daqs il-kapaċità supplementari ta-taħsin, sup(Tj).	(*) Voor ruimteverwarmingstoestellen met warmtepomp en combinatieverwarmingstoestellen met warmtepomp, is de nominale warmteafgifte Prated gelijk aan de ontwerpbelasting voor verwarming Pdesignh, en is de nominale warmteafgifte van een aanvullend verwarmingstoestel Psup gelijk aan het aanvullend vermogen voor verwarming sup(Tj).
AZ	(**) Jei Cđh nenustatomas matuojant, naudojama numatytoji blogėjimo koeficiento verte Cđh = 0,9.	(**) Amennyiben a Cđh értéket nem mérésrel állapítják meg, akkor az alapértelmezett degradációs tényező: Cđh = 0,9.	(**) Jekk il-koeffiċjent ta' degradazzjoni, Cđh, ma jigiġ stabilill bil-keġ, b'mod awtomatiku jitqies li huwa ta' Cđh = 0,9.	(**) Als Cđh niet door meting is bepaald, is de standaardwaarde van de verliescoëfficiënt Cđh = 0,9.
BA	1) Atliėkant montavimo ir aptarnavimo darbus privaloma laikytis atsargumų priemonių, nurodytų diegimo/vartotojo vadove.	1) A termék összeszerelése, telepítése és a karbantartása során tartsa be a telepítési/használati útmutatóban leírt óvintézkedéseket.	1) Prekawzjonijiet kif deskritt fl-installazzjoni u l-utent manwali għandhom jittieħdu meta jlaqqa l-installazzjoni, u z-zamma dan il-prodott	1) De voorzorgsmaatregelen die in de gebruikershandleiding worden beschreven, moeten in acht worden genomen bij montage, installatie en onderhoud van dit product.
BB	2) Jei esate specialistas ir ieškote informacijos kaip išardyti įrangą jos nepažeidžiant, parašykite el. laišką adresu: erims.sec@samsung.com	2) Ha Ön szakember, és információt keres az ártalmatlan szétszerelés és bontással kapcsolatban, kérjük, küldjön egy e-mailt az: erims.sec@samsung.com címre.	2) Jekk inti persuna professjonali u qed tiffix informazzjoni fuq ammar u zarmar li ma jaghmlix danni, jekk jogħbhok ibagħat email fuq: erims.sec@samsung.com	2) Als u als professional op zoek bent naar informatie over de niet- destructieve demontage en ontmanteling, stuur dan een e-mail naar: erims.sec@samsung.com

COMMISSION REGULATION (EU) No 813/2013¹⁾

No	Polish(PL)	Portuguese(PT)	Romanian(RO)	Slovak(SK)
I	ROZPORZĄDZENIE KOMISJI (UE) NR 813/2013	REGULAMENTO (UE) No 813/2013 DA COMISSÃO	NARIAĐENIE KOMISIE (EÚ) č. 813/2013	NARIAĐENIE KOMISIE (EÚ) č. 813/2013
II	Wymogi dotyczące ekoprojektu dla ogrzewaczy pomieszczeń	Os requisitos de conceção ecológica para aquecedor de ambiente	Požiadavky na ekodizajn tepelný zdroj na vykurovanie priestoru	Požiadavky na ekodizajn tepelný zdroj na vykurovanie priestoru
A	Model(-e); [dane określające modele, do których odnosi się informacja]	Modelo(s); [dados de identificação do(s) modelo(s) a que se refere a informação]	Model(-y); [informácie na určenie modelu(-ov), ktorého(-ých) sa informácie týkajú]	Model(-y); [informácie na určenie modelu(-ov), ktorého(-ých) sa informácie týkajú]
B	Pompa ciepła powietrze/woda: [tak/nie]	Bomba de calor ar-água: [sim/não]	Tepelné čerpadlo vzduch – voda: [áno/nie]	Tepelné čerpadlo vzduch – voda: [áno/nie]
C	Pompa ciepła woda/woda: [tak/nie]	Bomba de calor água-água: [sim/não]	Tepelné čerpadlo voda – voda: [áno/nie]	Tepelné čerpadlo voda – voda: [áno/nie]
D	Pompa ciepła solanka/woda: [tak/nie]	Bomba de calor salmoura-água: [sim/não]	Tepelné čerpadlo slaná voda – voda: [áno/nie]	Tepelné čerpadlo studničná voda – voda: [áno/nie]
E	Niskotemperaturowa pompa ciepła: [tak/nie]	Bomba de calor de baixa temperatura: [sim/não]	Nizkoteplotné tepelné čerpadlo: [áno/nie]	Nizkoteplotné tepelné čerpadlo: [áno/nie]
F	Wyposażona w dodatkowy ogrzewacz: [tak/nie]	Equipada com um aquecedor suplementar: [sim/não]	Vybavené dodatočným tepelným zdrojom: [áno/nie]	Vybavené dodatočným tepelným zdrojom: [áno/nie]
G	Wielofunkcyjny ogrzewacz z pompą ciepła: [tak/nie]	Aquecedor combinado com bomba de calor: [sim/não]	Kombinovaný tepelný zdroj – tepelné čerpadlo: [áno/nie]	Kombinovaný tepelný zdroj – tepelné čerpadlo: [áno/nie]
H	Parametry podaje się dla zastosowań w średnich temperaturach, z wyjątkiem niskotemperaturowych pomp ciepła. W przypadku niskotemperaturowych pomp ciepła parametry podaje się dla zastosowań w niskich temperaturach.	Devem ser indicados parâmetros para aplicação a média temperatura, exceto para as bombas de calor de baixa temperatura. Para as bombas de calor de baixa temperatura, devem ser indicados parâmetros para aplicação a baixa temperatura.	Parametre sa deklaruju pre použitie pri stredných teplotách, okrem tepelných čerpadiel pre nízke teploty. V prípade tepelných čerpadiel pre nízke teploty sa parametre deklaruju pre použitie pri nízkych teplotách.	Parametre majú byť deklarované pre použitie pri stredných teplotách, okrem tepelných čerpadiel pre nízke teploty. V prípade tepelných čerpadiel pre nízke teploty sa parametre majú byť deklarované pre použitie pri nízkych teplotách.
I	Parametry są deklarowane dla warunków klimatu umiarkowanego.	Os parâmetros declarados devem corresponder a condições climáticas médias.	Parametre sa deklaruju pre priemerné klimatické podmienky.	Parametre majú byť deklarované pre priemerné klimatické podmienky.
J	Parametr	Elemento	Položka	Položka
K	Symbol	Símbolo	Symbol	Symbol
L	Wartość	Valor	Hodnota	Hodnota
M	Jednostka	Unidade	Jednotka	Jednotka
N	Znamionowa moc cieplna (*)	Potência calorífica nominal (*)	Menovitý tepelný výkon (*)	Menovitý tepelný výkon (*)
O	Prated	Prated	Prated	Prated
P	Sezonowa efektywność energetyczna ogrzewania pomieszczeń	Eficiência energética do aquecimento ambiente sazonal	Sezónna energetická účinnosť vykurovania	Sezónna energetická účinnosť vykurovania
Q	Deklarowana wydajność grzewcza przy częściowym obciążeniu w temperaturze pomieszczenia 20 °C i temperaturze zewnętrznej Tj	Capacidade declarada para aquecimento a carga parcial a uma temperatura interior de 20 °C e a uma temperatura exterior Tj	Deklarovaný tepelný výkon pre čiastočné zaťaženie pri vnútornej teplote 20 °C a vonkajšej teplote Tj	Deklarovaný tepelný výkon pre čiastočné zaťaženie pri vnútornej teplote 20 °C a vonkajšej teplote Tj
R	Deklarowany wskaźnik efektywności lub wskaźnik zużycia energii pierwotnej przy częściowym obciążeniu w temperaturze pomieszczenia 20 °C i temperaturze zewnętrznej Tj	Coefficiente de desempenho declarado ou rácio de energia primária a carga parcial a uma temperatura interior de 20 °C e a uma temperatura exterior Tj	Deklarovaný vykurovací súčiniteľ alebo súčiniteľ využitia primárnej energie pre čiastočné zaťaženie pri vnútornej teplote 20 °C a vonkajšej teplote Tj	Deklarovaný vykurovací súčiniteľ alebo súčiniteľ využitia primárnej energie pre čiastočné zaťaženie pri vnútornej teplote 20 °C a vonkajšej teplote Tj
S	COPd lub PERd	COPd or PERd	COPd alebo PERd	COPd alebo PERd
T	Tj = temperatura dwuwartościowa	Tj = temperatura bivalente	Tj = bivalentná teplota	Tj = teplota bivalencie
U	Tj = graniczna temperatura robocza	Tj = temperatura-limite de funcionamento	Tj = prevádzková hraničná teplota	Tj = hraničná prevádzková teplota
V	Pompy ciepła powietrze/woda: Tj = -15 °C (jeżeli TOL < -20 °C)	Para bombas de calor ar-água: Tj = -15 °C (se TOL < -20 °C)	Pre tepelné čerpadlá vzduch – voda: Tj = -15 °C (ak TOL < -20 °C)	Pre tepelné čerpadlá vzduch – voda: Tj = -15 °C (ak TOL < -20 °C)
W	Temperatura dwuwartościowa	Temperatura bivalente	Bivalentná teplota	Teplota bivalencie
X	Pompy ciepła powietrze/woda: Graniczna temperatura robocza	Para bombas de calor ar-água: Temperatura-limite de funcionamento	Pre tepelné čerpadlá vzduch – voda: Hraničná prevádzková teplota	Pre tepelné čerpadlá vzduch – voda: Hraničná prevádzková teplota
Y	Wydajność w okresie cyklu w interwale dla ogrzewania	Capacidade de aquecimento em intervalo cíclico	Výkon v rámci cyklického intervalu pre vykurovanie	Výkon v rámci cyklického intervalu pre vykurovanie
Z	Wydajność w okresie cyklu w interwale	Eficiência em intervalo cíclico	Súčiniteľ v rámci cyklického intervalu	Súčiniteľ v rámci cyklického intervalu
AA	COPcyc lub PERcyc	COPcyc or PERcyc	COPcyc alebo PERcyc	COPcyc alebo PERcyc
AB	Współczynnik strat (**)	Coefficiente de degradação (**)	Súčiniteľ straty účinnosti (**)	Súčiniteľ straty účinnosti (**)
AC	Graniczna temperatura robocza dla podgrzewania wody	Temperatura-limite de funcionamento para água de aquecimento	Hraničná prevádzková teplota pre ohrev úžitkovej vody	Hraničná prevádzková teplota pre ohrev vody

No	Polish(PL)	Portuguese(PT)	Romanian(RO)	Slovak(SK)
AD	Pobór mocy w trybach innych niż aktywne	Consumo energético em modos distintos do modo ativo	Elektrický príkon v iných režimoch ako aktívny režim	Spotreba el. energie v iných režimoch ako aktívnych
AE	Ogrzewacz dodatkowy	Aquecedor suplementar	Dodatčný tepelný zdroj	Dodatčný tepelný zdroj
AF	Tryb wyłączenia	Modo desligado	Režim vypnutia	Režim vypnutia
AG	Tryb wyłącznego termostatu	Modo termostato desligado	Režim vypnutia termostatu	Režim vypnutia termostatu
AH	Tryb czuwania	Modo de vigília	Pohotovostný režim	Pohotovostný režim
AI	Tryb włącznej grzałki karteru	Modo de resistência do cárter	Režim ohrevu kľukovej skrine	Režim nahrievania oleja
AJ	Rodzaj pobieranej energii	Tipo de alimentação de energia	Typ elektrického príkonu	Typ elektrického príkonu
AK	Inne parametry	Outros elementos	Alți parametri	Iné položky
AL	Regulacja wydajności	Controlo de capacidade	Regulácia výkonu	Regulácia výkonu
AM	wydajność stała/zmienna	fixo/variável	Pevná/premenlivá	Pevná/premenlivá
AN	Pompy ciepła powietrze/woda: znamionowy przepływ powietrza na zewnątrz	Para bombas de calor ar-água: Caudal de ar nominal, exterior	Pre tepelné čerpadlá vzduch – voda: Menovitý prietok vzduchu, von	Pre tepelné čerpadlá vzduch – voda: Menovitý prietok vzduchu, exteriér
AO	m ³ /h	m ³ /h	m ³ /h	m ³ /h
AP	Poziom mocy akustycznej w pomieszczeniu/ na zewnątrz	Nível de potência sonora interior/exterior	Vnútomá/vonkajšia hladina akustického výkonu	Vnútomá/vonkajšia hladina akustického výkonu
AQ	Emisje tlenków azotu	Emissões de óxidos de azoto	Emisie oxidov dusika	Emisie oxidov dusika
AR	Pompy ciepła woda/solanka-woda: znamionowe natężenie przepływu solanki lub wody, zewnętrzny wymiennik ciepła	Para bombas de calor água/salmoura-água: Caudal nominal de salmoura ou água, permutador térmico exterior	Pre tepelné čerpadlá voda/slaná voda – voda: Menovitý prietok slanej vody alebo vody, vonkajší výmenník tepla	Pre tepelné čerpadlá voda/studničná voda – voda: Menovitý prietok studničnej vody alebo vody, vonkajší výmenník tepla
AS	Wielofunkcyjne ogrzewacze z pompą ciepła:	Para aquecedores combinados com bomba de calor:	Pre kombinovaný tepelný zdroj – tepelné čerpadlo:	Pre kombinovaný tepelný zdroj tepelného čerpadla:
AT	Deklarowany profil obciążeń	Perfil de carga declarado	Deklarowany profil zaťaženia	Deklarovaný profil zaťaženia
AU	Efektywność energetyczna podgrzewania wody	Eficiência energética do aquecimento de água	Energetická účinnosť prípravy teplej vody	Energetická účinnosť prípravy teplej vody
AV	Dzienne zużycie energii elektrycznej	Consumo diário de eletricidade	Denná spotreba elektrickej energie	Denná spotreba elektrickej energie
AW	Dzienne zużycie paliwa	Consumo diário de combustível	Denná spotreba paliwa	Denná spotreba paliwa
AX	Dane kontaktowe	Elementos de contacto	Kontaktné údaje	Kontaktné údaje
AY	(*) W przypadku ogrzewaczy pomieszczeń z pompą ciepła i wielofunkcyjnych ogrzewaczy z pompą ciepła znamionowa moc cieplna Prated jest równa obciążeniu obliczeniowemu dla trybu ogrzewania Pdesighn, a znamionowa moc cieplna ogrzewacza dodatkowego Pspup jest równa dodatkowej wydajności grzewczej dla trybu ogrzewania sup(Tj).	(*) Para aquecedores de ambiente com bomba de calor e aquecedores combinados com bomba de calor, a potência calorífica nominal Prated é igual à carga de projeto para aquecimento Pdesighn e a potência calorífica nominal de um aquecedor suplementar Pspup é igual à capacidade de aquecimento suplementar sup(Tj).	(*) Pre tepelné zdroje na vykurovanie priestoru – tepelné čerpadlá a kombinované tepelné zdroje – tepelné čerpadlá sa menovitý tepelný výkon Prated rovná projektovanému vykurovaciemu zaťaženiu Pdesighn, a menovitý tepelný výkon dodatočného tepelného zdroja Pspup sa rovná dodatočnému tepelnému výkonu sup(Tj).	(*) Pre tepelné zdroje na vykurovanie priestoru – tepelné čerpadlá a kombinované tepelné zdroje sa menovitý tepelný výkon Prated rovná projektovanému vykurovaciemu zaťaženiu Pdesighn a menovitý tepelný výkon dodatočného tepelného zdroja Pspup sa rovná dodatočnému tepelnému výkonu sup(Tj).
AZ	(**) Jeżeli współczynnik Cdh nie został wyznaczony przez pomiar, współczynnik strat przyjmuje wartość domyślną Cdh = 0,9.	(**) Se não se determinar Cdh por medição, o coeficiente de degradação predefinido é Cdh = 0,9.	(**) Ak Cdh nie je určené meraním, implicitný súčiniteľ straty účinnosti je Cdh = 0,9.	(**) Ak Cdh nie je určené meraním, potom predvolený súčiniteľ straty účinnosti je Cdh = 0,9.
BA	1) W trakcie montażu, instalacji i obsługi tego produktu należy zachować zasady bezpieczeństwa opisane w instrukcji instalacji/obsługi.	1) As precauções descritas no manual de instalação/instruções dever ser adotadas durante a montagem, instalação ou manutenção do produto.	1) Trebuie să fiți precauți conform manualului de utilizare/instalare în timpul asamblării, instalării și întreținerii acestui produs.	1) Výstrahy ako sú popísané v inštaláčnom/ užívateľskom manuáli musia byť uvažované pri montáži, inštalácii a starostlivosti o produkt.
BB	2) Jeśli jesteś profesjonalistą szukającym informacji dotyczących nieniszczących metod demontażu i rozbiórkę, uprzejmie prosimy o wysłanie wiadomości email na adres: erims.sec@samsung.com	2) Se é um profissional e pretende obter informações sobre desmontagem e desmantelamento não destrutivos, envie um e-mail para: erims.sec@samsung.com	2) Odborní pracovníci môžu získať informácie týkajúce sa neštruktúrnej demontáže na nasledujúcej e-mailovej adrese: erims.sec@samsung.com.	2) Odborní pracovníci môžu získať informácie týkajúce sa správnej demontáže na nasledujúcej e-mailovej adrese: erims.sec@samsung.com.

COMMISSION REGULATION (EU) No 813/2013¹⁾

No	Slovenian(SL)	Finnish(FI)	Swedish(SV)
I	UREDBA KOMISIJE (EU) št. 813/2013	KOMISSION ASETUS (EU) No 813/2013,	KOMMISSIONENS FÖRORDNING (EU) nr 813/2013
II	Okojloslo primerno zasnovano zahtevo za grelnik prostorov	Ekosuunnitteluvaatimukset varten tilälämmittimellä	Ekodesignkraven för rumsuppvärmning
A	Model(-i): [informacije za identifikacijo modela(-lov), na katere se informacije nanašajo]	Malli(t): [tiedot sen mallin (niden mallien) yksilöimiseksi, jotta tiedot koskevat]	Modeller): [Information som identifierar den modell (de modeller) som informationen gäller]
B	Toplotna črpalka zrak-voda: [da/ne]	Ilma-vesi-lämpöpumppu: [kyllä/ei]	Luft-till-vatten-värmepump: [ja/nej]
C	Toplotna črpalka voda-voda: [da/ne]	Vesi-vesi-lämpöpumppu: [kyllä/ei]	Vatten-till-vatten-värmepump: [ja/nej]
D	Toplotna črpalka slanica-voda: [da/ne]	Suolavesi-vesi-lämpöpumppu: [kyllä/ei]	Saltlösning-till-vatten-värmepump: [ja/nej]
E	Nizkotemperaturna toplotna črpalka: [da/ne]	Matalan lämpötilan lämpöpumppu: [kyllä/ei]	Lågtemperaturvärmepump: [ja/nej]
F	Opremljena z dodatnim grelnikom: [da/ne]	Varustettu lisälämmittimellä: [kyllä/ei]	Urustad med extra värmegenerator: [ja/nej]
G	Kombinirani grelnik s toplotno črpalko: [da/ne]	Lämpöpumppuyhdistelmälämmitin: [kyllä/ei]	Pannor med inbyggd tappvarmvattenberedning och med värmepump: [ja/nej]
H	Parametri se navedejo za uporabo pri srednji temperaturi, razen za nizkotemperaturne toplotne črpalke. Parametri za nizkotemperaturne toplotne črpalke se navedejo za uporabo pri nizki temperaturi.	Parametrit ilmoitetaan keskilämpötilan sovelluksesta, lukuun ottamatta matalan lämpötilan lämpöpumppuja. Matalan lämpötilan lämpöpumppuista parametrit ilmoitetaan matalan lämpötilan sovelluksesta.	Parametrar ska anges för mediumtemperaturlämpning, utom för lågtemperaturvärmepumpar. För lågtemperaturvärmepumpar ska parametrarna anges för lågtemperaturapplikationer.
I	Parametri se navedejo za povprečne podnebne razmere.	Parametrit ilmoitetaan keskimääräisissä ilmasto-olosuhteissa.	Parametrarna ska anges för genomsnittliga klimatförhållanden.
J	Postavka	Kohta	Post
K	Oznaka	Symboli	Beteckning
L	Vrednost	Arvo	Värde
M	Enota	Yksikkö	Enhet
N	Nazivna izhodna toplota (*)	Nimelläsiämpöteho (*)	Nominell given värmeeffekt (*)
O	Prated	Prated	Pmärk
P	Sezonska energijska učinkovitost ogrevanja prostorov	Tilälämmityksen kausittainen energiatehokkuus	Säsongmedelverkningsgrad för rumsuppvärmning
Q	Prijavljena zmogljivost ogrevanja za delno obremenitev pri temperaturi v notranjih prostorih 20 °C in temperaturi na prostem Tj	Ilmoitettu lämmitysteho osakuormalla sisälämpötilassa 20 °C ja ulkolämpötilassa Tj	Deklarerad kapacitet för uppvärmning för delbelastning vid innetemperatur 20 °C och utetemperatur Tj
R	Prijavljen koeficient učinkovitosti ali razmerje primarne energije za delno obremenitev pri temperaturi v notranjih prostorih 20 °C in temperaturi na prostem Tj	Ilmoitettu lämpökerroin tai primäärienergiakerroin osakuormalla sisälämpötilassa 20 °C ja ulkolämpötilassa Tj	Deklarerad värmefaktor eller primärenergifaktor för delbelastning vid en inomhustemperatur på 20 °C och en utomhustemperatur Tj
S	COPd ali PERd	COPd tai PERd	COPd eller PERd
T	Tj = bivalentna temperatura	Tj = kaksiarvoinen lämpötila	Tj = bivalenttemperatur
U	Tj = mejna delovna temperatura	Tj = toimintarajälämpötila	Tj = gränstemperatur för drift
V	Za toplotne črpalke zrak-voda: Tj = -15 °C (če je TOL < -20 °C)	Ilma-vesi-lämpöpumput: Tj = -15 °C (jos TOL < -20 °C)	För luft-till-vatten-värmepumpar: Tj = -15 °C (om TOL < -20 °C)
W	Bivalentna temperatura	Kaksiarvoinen lämpötila	Bivalenttemperatur
X	Za toplotne črpalke zrak-voda: mejna delovna temperatura	Ilma-vesi-lämpöpumput: Toimintarajälämpötila	För luft-till-vatten-värmepumpar: Gränstemperatur för drift
Y	Zmogljivost intervala cikla za ogrevanje	Lämmityksen vuorottelujaksoteho	Cykelintervallets uppvärmningskapacitet
Z	Učinkovitost intervala cikla	Vuorottelujakson energiatehokkuus	Cykelintervallets verkningsgrad
AA	COPcyc ali PERcyc	COPcyc tai PERcyc	COPcyc eller PERcyc
AB	Koeficient degradacije (**)	Alenemiskerroin (**)	Degraderingskoefficient (**)
AC	Mejna delovna temperatura za ogrevanje vode	Lämmitysveden toimintarajälämpötila	Uppvärmningsvattnets gränstemperatur för drift
AD	Poraba energije v načinih, ki ne vključujejo načina aktivnega delovanja	Tehonkulutus muissa tiloissa kuin aktiivisessa toimintalassa	Effektförbrukning i andra lägen än aktivt läge
AE	Dodatni grelnik	Lisälämmitin	Extra värmegenerator
AF	Stanje izključenosti	Pois päältä -tila	Frånläge

No	Slovenian(SL)	Finnish(FI)	Swedish(SV)
AG	Stanje izključenosti termostata	Termostaatti pois päältä-tila	Termostatfrånläge
AH	Stanje pripravljenosti	Valmiustila	Standbyläge
AI	Nacin grelnika ohija	Kampikammion lämmitys-tila	Vevhvärmärläge
AJ	Vrsta dovedene energije	Ottoenergian tyyppi	Typ av tillförd energi
AK	Druge postavke	Muut kohdat	Andra poster
AL	Upravljanje zmogljivosti	Tehosäätiö	Kapacitetsreglering
AM	stalna/spremenljiva	kiinteä/muuttuva	fast/variabel
AN	Za toplotne črpalke zrak-voda: nazivna stopnja pretoka zraka, zunanja	Ilma-vesi-lämpöpumput: nimellismavirta, ulkona	För luft-till-vatten-värmepumpar: Nominellt luftflöde (ute)
AO	m ³ /h	m ³ /h	m ³ /h
AP	Nivo zvokovne moči, v notranjih prostorih/na prostem	Äänitehotaso, sisällä/ulkona	Ljudeffektiv, inomhus/utomhus
AQ	Emisije dušikovih oksidov	Typen oksidien päästöt	Utsläpp av kväveoxider
AR	Za toplotne črpalke voda/slanica-voda: nazivna stopnja pretoka slance ali vode, zunanji izmenjevalnik toplote	Vesi-/suolavesi-vesi-lämpöpumput: suolaveden tai veden nimellisvirtaus, ulkolämmönsiirrin	För vatten-/saltlösning-till-vatten-värmepumpar: Nominellt saltlösning- eller vattenflöde, värmväxlare utomhus
AS	Za kombinirani grelnik s toplotno črpalco:	Lämpöpumppuyhdistelmälämmitin:	För pannor med inbyggd tappvarmvattenberedning och med värmepump:
AT	Določeni profil rabe	Ilmoitettu kuormitusprofiili	Deklarerad belastningsprofil
AU	Energijska učinkovitost ogrevanja vode	Vedenlämmityksen energiatehokkuus	Energieffektivitet vid uppvärmning av vatten
AV	Dnevna poraba električne energije	Vuorokautinen sähkönkulutus	Daglig elförbrukning
AW	Dnevna poraba goriva	Vuorokautinen polttoaineenkulutus	Daglig bränsleförbrukning
AX	Kontaktni podatki	Yhteydet	Kontakt
AY	(*) Za toplotne črpalke za ogrevanje prostorov in kombinirane grelnike s toplotno črpalco je nazivna izhodna toplota Prated enaka nazivni obremenitvi za ogrevanje Pdesignh, nazivna izhodna toplota dodatnega grelnika Psup pa je enaka dodatni zmogljivosti ogrevanja sup(Tj).	(*) Lämpöpumpputilälämmittimillä ja lämpöpumppuyhdistelmälämmittimillä nimellislämpöteho Prated on yhtä suuri kuin lämmityksen mitoituskuorma Pdesignh ja lisälämmittimen nimellislämpöteho Psup on yhtä suuri kuin lisälämmitysteho sup(Tj).	(*) För värmare med värmepump för rumsuppvärmning och pannor med inbyggd tappvarmvattenberedning och med värmepump är den nominella avgivna värmeeffekten Prated lika med den dimensionerade värmekapaciteten Pdesignh, och den nominella avgivna värmeeffekten hos en extra värmegenerator Psup är lika med den kompletterande uppvärmningskapaciteten sup(Tj).
AZ	(**) Če Cdh ni določen z meritvami, privzeti koeficient degradacije znaša Cdh = 0,9.	(**) Jos Cdh:n arvoa ei määritetä mittamalla, alenemiskertoimen oletusarvo on Cdh = 0,9.	(**) Om Cdh inte bestäms genom mätningar ska degraderingskoefficienten vara Cdh = 0,9.
BA	1) Pri sestavljanju, nameščanju ter vzdrževanju izdelka upoštevajte previdnostne ukrepe, ki so navedeni v priročniku za uporabo in namestitve.	1) Asennus- tai käyttöoppaassa kuvattuja turvaohjeita on noudatettava laitteen kokoamisen, asentamisen ja huollon aikana.	1) Försiktighetsåtgärderna som beskrivs i installationsmanualen/bruksanvisningen måste följas vid montering, installation och underhåll av denna produkt.
BB	2) Če ste strokovnjak in iščete informacije o neporušitvenem razstavljanju in demontaži, pošljite e-poštno sporočilo na: erims.sec@samsung.com	2) Jos olet ammattiasentaja ja haluat lisätietoja asennuksen turvallisesta purkamisesta, lähetätkää sähköpostia osoitteeseen erims.sec@samsung.com	2) Om du är en professionell användare som letar efter information om icke-destruktiv demontering och isärtagande av dammsugaren, kan du skicka ett e-postmeddelande till: erims.sec@samsung.com

COMMISSION DELEGATED REGULATION (EU) No 811/2013 ⁱ⁾

PRODUCT FICHE (ENERGY LABELLING OF SPACE HEATERS) ⁱⁱ⁾

a	Supplier's name or trademark		Samsung Electronics Co., Ltd.	Samsung Electronics Co., Ltd.	Samsung Electronics Co., Ltd.	Samsung Electronics Co., Ltd.
b	Supplier's model identifier		AE090JYDEH	AE090JYDGH	AE120JYDEH	AE120JYDGH
c	Seasonal space heating energy efficiency class	Medium-temperature ⁹⁾	-	A++	A++	A+
		Low-temperature ⁹⁾	-	A++	A++	A++
d	Rated heat output (Average)	Medium-temperature ⁹⁾	kW	6	5	8
		Low-temperature ⁹⁾	kW	7	6	11
e	Seasonal space heating energy efficiency (Average)	Medium-temperature ⁹⁾	%	126	125	115
		Low-temperature ⁹⁾	%	176	176	178
f	Annual energy consumption (Average)	Medium-temperature ⁹⁾	kWh	2764	2236	3889
		Low-temperature ⁹⁾	kWh	2159	1778	3327
g	L _{WA} (sound power level, indoor)		dB	-	-	-
h	Specific precautions ¹⁾		-	-	-	-
i	Rated heat output (Colder)	Medium-temperature ⁹⁾	kW	6	5	8
		Low-temperature ⁹⁾	kW	6	6	11
j	Rated heat output (Warmer)	Medium-temperature ⁹⁾	kW	6	5	8
		Low-temperature ⁹⁾	kW	7	6	11
k	Seasonal space heating energy efficiency (Colder)	Medium-temperature ⁹⁾	%	113	106	99
		Low-temperature ⁹⁾	%	158	156	152
l	Seasonal space heating energy efficiency (Warmer)	Medium-temperature ⁹⁾	%	157	147	160
		Low-temperature ⁹⁾	%	246	200	214
m	Annual energy consumption (Colder)	Medium-temperature ⁹⁾	kWh	4155	3868	6774
		Low-temperature ⁹⁾	kWh	3235	3008	5843
n	Annual energy consumption (Warmer)	Medium-temperature ⁹⁾	kWh	2209	2054	2933
		Low-temperature ⁹⁾	kWh	1548	1733	2989
o	L _{WA} (sound power level, outdoor)		dB	63	63	64

a	Supplier's name or trademark		Samsung Electronics Co., Ltd.	Samsung Electronics Co., Ltd.	Samsung Electronics Co., Ltd.	Samsung Electronics Co., Ltd.
b	Supplier's model identifier		AE140JYDEH	AE140JYDGH	AE160JYDEH	AE160JYDGH
c	Seasonal space heating energy efficiency class	Medium-temperature ⁹⁾	-	A+	A+	A+
		Low-temperature ⁹⁾	-	A++	A++	A++
d	Rated heat output (Average)	Medium-temperature ⁹⁾	kW	9	9	10
		Low-temperature ⁹⁾	kW	12	12	13
e	Seasonal space heating energy efficiency (Average)	Medium-temperature ⁹⁾	%	114	114	112
		Low-temperature ⁹⁾	%	177	177	176
f	Annual energy consumption (Average)	Medium-temperature ⁹⁾	kWh	4175	4175	4750
		Low-temperature ⁹⁾	kWh	3634	3634	3968
g	L _{WA} (sound power level, indoor)		dB	-	-	-
h	Specific precautions ¹⁾		-	-	-	-
i	Rated heat output (Colder)	Medium-temperature ⁹⁾	kW	9	9	10
		Low-temperature ⁹⁾	kW	12	12	13
j	Rated heat output (Warmer)	Medium-temperature ⁹⁾	kW	9	9	10
		Low-temperature ⁹⁾	kW	12	12	13
k	Seasonal space heating energy efficiency (Colder)	Medium-temperature ⁹⁾	%	98	98	107
		Low-temperature ⁹⁾	%	153	153	160
l	Seasonal space heating energy efficiency (Warmer)	Medium-temperature ⁹⁾	%	162	162	164
		Low-temperature ⁹⁾	%	214	214	209
m	Annual energy consumption (Colder)	Medium-temperature ⁹⁾	kWh	7256	7256	7444
		Low-temperature ⁹⁾	kWh	6305	6305	6579
n	Annual energy consumption (Warmer)	Medium-temperature ⁹⁾	kWh	3241	3241	3551
		Low-temperature ⁹⁾	kWh	3245	3245	3587
o	L _{WA} (sound power level, outdoor)		dB	65	65	66

r ¹⁾ Precautions as described in the installation/user manual must be taken when assembling, installing and maintaining this product.

PRODUCT FICHE (ENERGY LABELLING OF PACKAGES OF SPACE HEATER) ⁱⁱⁱ⁾

a	Supplier's name or trademark		Samsung Electronics Co., Ltd.	Samsung Electronics Co., Ltd.	Samsung Electronics Co., Ltd.	Samsung Electronics Co., Ltd.
b	Supplier's model identifier		AE090JYDEH	AE090JYDGH	AE120JYDEH	AE120JYDGH
s	Seasonal space heating energy efficiency (Preferential space heater)	%	128	127	117	117
t	Factor for weighting the heat output (Preferential space heater)	-	0	0	0	0
u	Mathematical expression : $294 / (11 \cdot Prated)$ ¹⁾	-	4.5	5.3	3.3	3.3
v	Mathematical expression : $115 / (11 \cdot Prated)$ ²⁾	-	1.7	2.1	1.3	1.3
w	The difference between the seasonal space heating energy efficiencies under average and colder climate conditions ³⁾	%	13	19	16	16
x	The difference between the seasonal space heating energy efficiencies under warmer and average climate conditions ⁴⁾	%	31	22	45	45

a	Supplier's name or trademark		Samsung Electronics Co., Ltd.	Samsung Electronics Co., Ltd.	Samsung Electronics Co., Ltd.	Samsung Electronics Co., Ltd.
b	Supplier's model identifier		AE140JYDEH	AE140JYDGH	AE160JYDEH	AE160JYDGH
s	Seasonal space heating energy efficiency (Preferential space heater)	%	116	116	114	114
t	Factor for weighting the heat output of the preferential and supplementary heaters	-	0	0	0	0
u	Mathematical expression : $294 / (11 \cdot Prated)$ ¹⁾	-	3.0	3.0	2.7	2.7
v	Mathematical expression : $115 / (11 \cdot Prated)$ ²⁾	-	1.2	1.2	1.0	1.0
w	The difference between the seasonal space heating energy efficiencies under average and colder climate conditions ³⁾	%	16	16	5	5
x	The difference between the seasonal space heating energy efficiencies under warmer and average climate conditions ⁴⁾	%	48	48	52	52

y ¹⁾ Whereby Prated is related to the preferential space heater.

z ²⁾ Whereby Prated is related to the preferential space heater.

aa ^{3),4)} For preferential heat pump space heaters.

PRODUCT FICHE (ENERGY LABELLING OF TEMPERATURE CONTROLS) ^{iv)}

a	Supplier's name or trademark	-	Samsung Electronics Co., Ltd.
b	Supplier's model identifier	-	MIM-E03AN
ab	The class of the temperature control	-	Class II
ac	The contribution of the temperature control to seasonal space heating energy efficiency	%	2

COMMISSION DELEGATED REGULATION (EU) No 811/2013 ⁱ⁾

No	English(EN)	Bulgarian(BG)	Spanish(ES)	Czech(CS)
i	COMMISSION DELEGATED REGULATION (EU) No 811/2013	ДЕЛЕГИРАН РЕГЛАМЕНТ (ЕС) № 811/2013 НА КОМИСИЯТА	REGLAMENTO DELEGADO (UE) No 811/2013 DE LA COMISIÓN	NAŘÍZENÍ KOMISE V PŘENESENÉ PRÁVOMOCI (EU) č. 811/2013
ii	PRODUCT FICHE (ENERGY LABELLING OF SPACE HEATERS)	Продуктов фиш (енергийното етикетирание на отоплителни топлоизточници)	Ficha del producto (etiquetado energético de aparatos de calefacción)	Informační list výrobku (energie na energetických štítcích ohřívačů pro vytápění vnitřních prostorů)
iii	PRODUCT FICHE (ENERGY LABELLING OF PACKAGES OF SPACE HEATER)	Продуктов фиш (енергийното етикетирание на КОМПЛЕКТИ ОТ ОТОПИТЕЛЕН ТОПЛОИЗТОЧНИК)	Ficha del producto (etiquetado energético de EQUIPOS COMBINADOS DE APARATO DE CALEFACCIÓN)	Informační list výrobku (energie na energetických štítcích ohřívačů pro souprav sestávajících z ohřívače pro vytápění vnitřních prostorů)
iv	PRODUCT FICHE (ENERGY LABELLING OF TEMPERATURE CONTROLS)	Продуктов фиш (енергийното етикетирание на	Ficha del producto (etiquetado energético de CONTROLES DE TEMPERATURA)	Informační list výrobku (energie na energetických štítcích ohřívačů pro regulátoru teploty)
a	Supplier's name or trademark	наименование или търговска марка на доставчика	nombre o marca comercial del proveedor	název nebo ochranná známka dodavatele
b	Supplier's model identifier	идентификатор на доставчика за модела	identificador del modelo del proveedor	identifikační značka modelu používaná dodavatelem
c	Seasonal space heating energy efficiency class	класът на сезонна отоплителна енергийна ефективност	la clase de eficiencia energética estacional de calefacción	třída sezonní energetické účinnosti vytápění
d	Rated heat output (Average)	номиналната топлинна мощност (средни)	la potencia calorífica nominal (medias)	jmennovitý tepelný výkon (průměrných)
e	Seasonal space heating energy efficiency (Average)	сезонната енергийна ефективност при отопление (средни)	la eficiencia energética estacional de calefacción (medias)	sezonní energetická účinnost vytápění (průměrných)
f	Annual energy consumption (Average)	годишното потребление на енергия (средни)	el consumo anual de energía (medias)	roční spotřeba energie (průměrných)
g	L _{WA} (sound power level, indoors)	L _{WA} (нивото на звуковата мощност, на закрито)	LWA (el nivel de potencia acústica, en interiores)	L _{WA} (případně hladina akustického výkonu, vnitřním prostorem)
h	Specific precautions ¹⁾	специфични предпазни	precauciones específicas ¹⁾	konkrétní preventivní opatření ¹⁾
i	Rated heat output (Colder)	номиналната топлинна мощност (по-студени)	la potencia calorífica nominal (l)	jmennovitý tepelný výkon (chladnějších)
j	Rated heat output (Warmer)	номиналната топлинна мощност (по-топли)	la potencia calorífica nominal (l)	jmennovitý tepelný výkon (teplejších)
k	Seasonal space heating energy efficiency (Colder)	сезонната енергийна ефективност при отопление (по-студени)	la eficiencia energética estacional de calefacción (más frías)	sezonní energetická účinnost vytápění (chladnějších)
l	Seasonal space heating energy efficiency (Warmer)	сезонната енергийна ефективност при отопление (по-топли)	la eficiencia energética estacional de calefacción (más cálidas)	sezonní energetická účinnost vytápění (teplejších)
m	Annual energy consumption (Colder)	годишното потребление на енергия (по-студени)	el consumo anual de energía (más frías)	roční spotřeba energie (chladnějších)
n	Annual energy consumption (Warmer)	годишното потребление на енергия (по-топли)	el consumo anual de energía (más cálidas)	roční spotřeba energie (teplejších)
o	L _{WA} (sound power level, outdoors)	L _{WA} (нивото на звуковата мощност, на открито)	LWA (el nivel de potencia acústica, en exteriores)	L _{WA} (případně hladina akustického výkonu, venkovním prostorem)
p	Medium-temperature	среднотемпературни	de temperatura media	středněteplotní
q	Low-temperature	нискотемпературни	de baja temperatura	nízokteplotním
r	¹⁾ Precautions as described in the installation/ user manual must be taken when assembling, installing and maintaining this product.	¹⁾ Описаните в ръководството за монтиране/ ръководството за потребителя предпазни мерки трябва да се спазват при събиране, монтиране и поддръжка на продукта.	¹⁾ Las precauciones descritas en los manuales de usuario e instalación deben tomarse cuando se ensambla, instala y mantiene este producto	¹⁾ Při montáži, instalaci a údržbě tohoto produktu je třeba se řídit bezpečnostními opatřeními popsányými v instalační a uživatelské příručce.
s	Seasonal space heating energy efficiency (Preferential space heater)	сезонната енергийна ефективност при отопление (приоритетно използвания отоплителен топлоизточник)	la eficiencia energética estacional de calefacción (aparato de calefacción preferente)	Seasonal space heating energy efficiency (preferovaného ohřívače pro vytápění vnitřních prostorů)
t	Factor for weighting the heat output of the preferential and supplementary heaters	тепловият коефициент за претегляне на топлината енергия, произведена от приоритетно използвания и от допълнителния подгревател на даден комплект	el factor de ponderación de la potencia calorífica de los calefactores preferente y complementario de un equipo combinado	factor pro porovnání tepelného výkonu preferovaného ohřívače a přidavných ohřívačů soupravy
u	Mathematical expression : 294 / (11 • Prated) ¹⁾	математическия израз : 294 / (11 • Prated) ¹⁾	la expresión matemática : 294 / (11 • Prated) ¹⁾	hodnotu matematického výrazu : 294 / (11 • Prated) ¹⁾
v	Mathematical expression : 115 / (11 • Prated) ²⁾	математическия израз : 115 / (11 • Prated) ²⁾	la expresión matemática : 115 / (11 • Prated) ²⁾	hodnotu matematického výrazu : 115 / (11 • Prated) ²⁾
w	The difference between the seasonal space heating energy efficiencies under average and colder climate conditions ³⁾	разликата между сезонната отоплителна енергийна ефективност при средни климатични условия и тази при по-студени климатични условия ³⁾	la diferencia entre las eficiencias energéticas estacionales de calefacción en condiciones climáticas medias y más frías, expresado en porcentaje	rozdíl sezonních energetických účinností vytápění za průměrných a chladnějších klimatických podmínek ³⁾
x	The difference between the seasonal space heating energy efficiencies under warmer and average climate conditions ⁴⁾	разликата между сезонната отоплителна енергийна ефективност при по-топли климатични условия и тази при средни климатични условия ⁴⁾	la diferencia entre las eficiencias energéticas estacionales de calefacción en condiciones climáticas más cálidas y medias, expresado en porcentaje	rozdíl sezonních energetických účinností vytápění za teplejších a průměrných klimatických podmínek ⁴⁾
y	¹⁾ Whereby Prated is related to the preferential space heater.	¹⁾ където Prated е свързана с приоритетно използвания отоплителен топлоизточник	¹⁾ donde la Prated está relacionada con el aparato de calefacción preferente	¹⁾ přičemž Prated se vztahuje k preferovanému ohřívači pro vytápění vnitřních prostorů
z	²⁾ Whereby Prated is related to the preferential space heater.	²⁾ където Prated е свързана с приоритетно използвания отоплителен топлоизточник	²⁾ donde la Prated está relacionada con el aparato de calefacción preferente	²⁾ preferovanému ohřívači pro vytápění vnitřních prostorů
aa	³⁾ / ⁴⁾ For preferential heat pump space heaters	³⁾ / ⁴⁾ за приоритетно използвани отоплителни термопомпни агрегати	³⁾ / ⁴⁾ en lo que respecta a los aparatos de calefacción preferentes con bomba de calor	³⁾ / ⁴⁾ preferovaných ohřívačů pro vytápění vnitřních prostorů s tepelným čerpadlem navíc
ab	The class of the temperature control	класът на регулатора на температура	la clase del control de temperatura	třída regulátoru teploty
ac	The contribution of the temperature control to seasonal space heating energy efficiency	приносът на регулатора на температура към сезонната енергийна ефективност при отопление	la contribución del control de temperatura a la eficiencia energética estacional de calefacción	přínos regulátoru teploty k sezonní energetické účinnosti vytápění

No	Danish(DA)	German(DE)	Estonian(ET)	Greek(EL)
i	KOMMISSIONENS DELEGEREDE FORORDNING (EU) Nr. 811/2013	DELEGIERTE VERORDNUNG (EU) Nr. 811/2013 DER KOMMISSION	KOMISJONI DELEGEERITUD MÄÄRUS (EL) nr 811/2013	ΚΑΤ' ΕΞΟΥΣΙΟΔΟΤΗΤΗ ΚΑΝΟΝΙΣΜΟΣ (ΕΕ) αριθ. 811/2013 ΤΗΣ ΕΠΙΤΡΟΠΗΣ
ii	Produktdatablad (energimærkning af anlæg til rumopvarmning)	Produktdatenblatt (Energiekennzeichnung von Raumheizgeräten)	Tootekirjeldus (energiamärgistusega kohta kütteseadmest)	Δελτίο προϊόντος (ενεργειακή επισήμανση των θερμαντήρων χώρου)
iii	Produktdatablad (energimærkning af anlæg til pakker med anlæg til rumopvarmning)	Produktdatenblatt (Energiekennzeichnung von Verbundanlagen aus Raumheizgeräten)	Tootekirjeldus (energiamärgistusega kohta kütteseadme, komplekt)	Δελτίο προϊόντος (ενεργειακή επισήμανση των των των συσκευημάτων θερμαντήρα χώρου)
iv	Produktdatablad (energimærkning af anlæg til temperaturstyring)	Produktdatenblatt (Energiekennzeichnung von Temperaturreglern)	Tootekirjeldus (energiamärgistusega kohta temperatuuriregulaatorist)	Δελτίο προϊόντος (ενεργειακή επισήμανση των ρυθμιστή θερμοκρασίας)
a	leverandørens navn eller varemærke	Name oder Warenzeichen des Lieferanten	tamija nimi või kaubamärk	το όνομα/η επωνυμία του προμηθευτή ή εμπορικό σήμα
b	leverandørens modelidentifikation	Modellkennung des Lieferanten	tamija mudelitähis	το αναγνωριστικό μοντέλου από τον προμηθευτή
c	klasse for årsvirkningsgrad ved rumopvarmning fastslået	die Klasse für die jahreszeitbedingte Raumheizungs-Energieeffizienz	kütmise seosone energiatõhususe klass	η τάξη ενεργειακής απόδοσης της εποχιακής θέρμανσης χώρου
d	den nominelle nytteeffekt (gennemsnitlige)	die Wärmenennleistung (durchschnittlichen)	nimisoojusvõimsus (keskmistel)	η ονομαστική θερμική ισχύς (μέσος)
e	årsvirkningsgraden ved rumopvarmning (gennemsnitlige)	die jahreszeitbedingte Raumheizungs-Energieeffizienz (durchschnittlichen)	kütmise seosone energiatõhusus (keskmistel)	η ενεργειακή απόδοση της εποχιακής θέρμανσης χώρου σε (μέσος)
f	det årlige energiforbrug (gennemsnitlige)	den jährlichen Energieverbrauch (durchschnittlichen)	aastane energiatarbimine (keskmistel)	ετήσια κατανάλωση ενέργειας (μέσος)
g	LWA (lydeffektivniveauet, inde)	LWA (den Schalleistungspegel, in Innenräumen)	LWA (müraavõimsustase, siseruumis)	LWA (η στάθμη ηχητικής ισχύος, εσωτερικού χώρου)
h	specifikke forholdsregler ¹⁾	besonderen Vorkehrungen ¹⁾	ettevaatusmeetmed kütteseadme koostamisel ¹⁾	ειδικές προφυλάξεις ¹⁾
i	den nominelle nytteeffekt (koldere)	die Wärmenennleistung (kälteren)	nimisoojusvõimsus (külmema)	η ονομαστική θερμική ισχύς (ψυχρότερες)
j	den nominelle nytteeffekt (varmere)	die Wärmenennleistung (wärmeren)	nimisoojusvõimsus (soojema)	η ονομαστική θερμική ισχύς (θερμότερες)
k	årsvirkningsgraden ved rumopvarmning (koldere)	die jahreszeitbedingte Raumheizungs-Energieeffizienz (kälteren)	kütmise seosone energiatõhusus (külmema)	η ενεργειακή απόδοση της εποχιακής θέρμανσης χώρου σε (ψυχρότερες)
l	årsvirkningsgraden ved rumopvarmning (varmere)	die jahreszeitbedingte Raumheizungs-Energieeffizienz (wärmeren)	kütmise seosone energiatõhusus (soojema)	η ενεργειακή απόδοση της εποχιακής θέρμανσης χώρου σε (θερμότερες)
m	det årlige energiforbrug (koldere)	den jährlichen Energieverbrauch (kälteren)	aastane energiatarbimine (külmema)	ετήσια κατανάλωση ενέργειας (ψυχρότερες)
n	det årlige energiforbrug (varmere)	den jährlichen Energieverbrauch (wärmeren)	aastane energiatarbimine (soojema)	ετήσια κατανάλωση ενέργειας (θερμότερες)
o	Lw (lydeffektivniveauet, ude)	Lw (den Schalleistungspegel, im Freien)	Lw (müraavõimsustase, väljas)	Lw (η στάθμη ηχητικής ισχύος, εξωτερικού χώρου)
p	mitteltemperatur	Mitteltemperatur	keskmisel temperatuuril	μέσος θερμοκρασίας
q	lavtemperatur	Niedertemperatur	külma kliima	χαμηλής θερμοκρασίας
r	¹⁾ Du skal tage de forholdsregler, der er beskrevet i installations-/brugervejledningen, når du samler, installerer og vedligeholder dette produkt.	¹⁾ Beim Montieren, Installieren und Warten des Geräts müssen die im Installations-/Benutzerhandbuch beschriebenen Vorsichtsmaßnahmen eingehalten werden.	¹⁾ Toote kokkupaneku, installimisel ja hooldamisel järgige paigaldus-/kasutusjuhendis kirjeldatud ettevaatusabinõusid.	¹⁾ Όταν συναρμολογείτε, εγκαθιστάτε και συντηρείτε αυτό το προϊόν, πρέπει να λαμβάνετε τις προφυλάξεις που περιγράφονται στο εγχειρίδιο εγκατάστασης/χρήσης.
s	årsvirkningsgraden ved rumopvarmning (det primære anlæg til rumopvarmning)	Seasonal space heating energy efficiency (Vorzugsraumheizgerätes)	kütmise seosone energiatõhusus (põhikütteseadme)	η ενεργειακή απόδοση της εποχιακής θέρμανσης χώρου σε (προτιμώμενο θερμαντήρα χώρου)
t	faktoren for vægning af den nominelle nytteeffekt af primære og supplerende forsyningsanlæg i en pakke	Faktor zur Gewichtung der Wärmeleistung der Vorzugs- und Zusatzheizgeräte	komplekti põhi- ja täiendavate kütteseadmete soojusvõimsuse kaalumistegur vastavalt käesoleva	ο συντελεστής στάθμησης της θερμικής ισχύος του προτιμώμενου και του συμπληρωματικού θερμαντήρα του συσκευημάτων.
u	værdien af det matematiske udtryk: $294 / (11 \cdot Prated)$ ¹⁾	Wert des mathematischen Ausdrucks: $294 / (11 \cdot Prated)$ ¹⁾	matemaatilise avaldise: $294 / (11 \cdot Prated)$ ¹⁾	η τιμή του μαθηματικού τύπου: $294 / (11 \cdot Prated)$ ¹⁾
v	værdien af det matematiske udtryk: $15 / (11 \cdot Prated)$ ²⁾	Wert des mathematischen Ausdrucks: $115 / (11 \cdot Prated)$ ²⁾	matemaatilise avaldise: $115 / (11 \cdot Prated)$ ²⁾	η τιμή του μαθηματικού τύπου: $115 / (11 \cdot Prated)$ ²⁾
w	værdien af forskellen mellem årsvirkningsgraden ved rumopvarmning under gennemsnitlige og koldere klimaforhold ³⁾	Wert der Differenz zwischen der jahreszeitbedingten Raumheizungs-Energieeffizienz bei durchschnittlichen und derjenigen bei kälteren Klimaverhältnissen ³⁾	keskmistel kliimatingimustel ja külmema kliima korral leitud kütmise seosonsete energiatõhususte vahe ³⁾	διαφοράς της ενεργειακής απόδοσης της εποχιακής θέρμανσης χώρου υπό μέσος και ψυχρότερες κλιματικές συνθήκες ³⁾
x	værdien af forskellen mellem årsvirkningsgraden ved rumopvarmning under varmere og gennemsnitlige klimaforhold ⁴⁾	Wert der Differenz zwischen der jahreszeitbedingten Raumheizungs-Energieeffizienz bei wärmeren und derjenigen bei durchschnittlichen Klimaverhältnissen ⁴⁾	soojema kliima korral ja keskmistel kliimatingimustel leitud kütmise seosonsete energiatõhususte vahe ⁴⁾	διαφοράς της ενεργειακής απόδοσης της εποχιακής θέρμανσης χώρου υπό θερμότερες και μέσος κλιματικές συνθήκες ⁴⁾
y	¹⁾ hvor Prated vedrører det primære anlæg til rumopvarmning	¹⁾ wobei sich Prated auf das Vorzugsraumheizgerät bezieht	¹⁾ siin Prated iseloomustab põhikütteseadet	¹⁾ όπου Prated αφορά τον προτιμώμενο θερμαντήρα χώρου
z	²⁾ hvor Prated vedrører det primære anlæg til rumopvarmning	²⁾ wobei sich Prated auf das Vorzugsraumheizgerät bezieht	²⁾ siin Prated iseloomustab põhikütteseadet	²⁾ όπου Prated αφορά τον προτιμώμενο θερμαντήρα χώρου
aa	^{3),4)} for primære varmpumpeanlæg til rumopvarmning	^{3),4)} für Vorzugsraumheizgeräte mit Wärmepumpe	^{3),4)} soojuspumbaega põhikütteseadmete kohta	^{3),4)} για τους προτιμώμενους θερμαντήρες χώρου με αντλία θερμότητας
ab	klasse for temperaturstyring	die Klasse des Temperaturreglers	temperatuuriregulaatori klass	η τάξη του ρυθμιστή θερμοκρασίας
ac	temperaturstyringens andel af årsvirkningsgraden ved rumopvarmning i procent afrundet til en decimal	Beitrag des Temperaturreglers zur jahreszeitbedingten Raumheizungs-Energieeffizienz	temperatuuriregulaatori osa kütmise seosoonsete energiatõhususes	το μερίδιο του ρυθμιστή θερμοκρασίας στην ενεργειακή απόδοση της εποχιακής θέρμανσης χώρου

COMMISSION DELEGATED REGULATION (EU) No 811/2013 ⁱ⁾

No	French(FR)	Croatian(HR)	Italian(IT)	Latvian(LV)
i	RÈGLEMENT DÉLÉGUÉ (UE) No 811/2013 DE LA COMMISSION	DELEGIрана UREDBA KOMISIJE (EU) br. 811/2013	REGOLAMENTO DELEGATO N. 811/2013 DELLA COMMISSIONE EUROPEA	KOMISIJA DELEĢĒTĀ REGULĀ (ES) Nr. 811/2013
ii	Fiche de produit (l'étiquetage énergétique des dispositifs de chauffage des locaux)	Informacijski list proizvoda (označivanja energetske učinkovitosti grijača prostora)	Scheda prodotto (l'etichetta indica il consumo d'energia degli apparati per il riscaldamento)	Ražojuma datu lapa (energomarkējumu uz telpu sildītāju)
iii	Fiche de produit (l'étiquetage énergétique des produit combiné constitué d'un dispositif de chauffage des locaux)	Informacijski list proizvoda (označivanja energetske učinkovitosti kompleta koji sadržavaju grijač prostora)	Scheda prodotto (l'etichetta indica il consumo d'energia degli insiemi di apparati per il riscaldamento)	Ražojuma datu lapa (energomarkējumu uz telpu sildītāja iekārtas, komplektu)
iv	Fiche de produit (l'étiquetage énergétique des d'un régulateur de température)	Informacijski list proizvoda (označivanja energetske učinkovitosti uređaj za upravljanje temperaturom)	Scheda prodotto (l'etichetta indica il consumo d'energia dispositivi di controllo della temperatura)	Ražojuma datu lapa (energomarkējumu uz temperatūras regulatori)
a	le nom du fournisseur ou la marque commerciale	naziv ili zaštitni znak dobavljača	il nome o marchio del fornitore	piegādātāja nosaukums vai preču zīme
b	la référence du modèle donnée par le fournisseur	dobavljačeva identifikacijska oznaka modela	Identificativo del modello del fornitore	piegādātāja modeļa identifikators
c	la classe d'efficacité énergétique saisonnière, pour le chauffage des locaux	razred sezonske energetske učinkovitosti pri zagrijavanju prostora	la classe di efficienza energetica stagionale di riscaldamento	telpu apsildes sezona energoefektivitātes klase
d	la puissance thermique nominale (moyennes)	nazivna toplinska snaga (prosječnim)	la potenza termica nominale (medie)	nomiņālā siltuma jauda (vidējais)
e	l'efficacité énergétique saisonnière pour le chauffage des locaux (moyennes)	sezonska energetska učinkovitost pri zagrijavanju prostora (prosječnim)	l'efficienza energetica stagionale di riscaldamento dell'ambiente (medie)	telpu apsildes sezona energoefektivitāte (vidējais)
f	la consommation annuelle d'énergie (moyennes)	godišnja potrošnja energije (prosječnim)	il consumo annuo di energia (medie)	gada enerģijas patēriņš (vidējais)
g	L _{wa} (le niveau de puissance acoustique, à l'intérieur)	L _{wa} (razina zvučne snage, u zatvorenom)	LWA (il livello di potenza sonora, interna)	L _{wa} (akustiskās jaudas līmenis, telpās)
h	les précautions particulières ¹⁾	posebne mjere opreza ¹⁾	eventuali precauzioni ¹⁾	īpaši piesardzības pasākumi ¹⁾
i	la puissance thermique nominale (plus froides)	nazivna toplinska snaga (hladnijim)	la potenza termica nominale (più fredde)	nomiņālā siltuma jauda (aukstākos)
j	la puissance thermique nominale (plus chaudes)	nazivna toplinska snaga (toplijim)	la potenza termica nominale (più calde)	nomiņālā siltuma jauda (siltākos)
k	l'efficacité énergétique saisonnière pour le chauffage des locaux (plus froides)	sezonska energetska učinkovitost pri zagrijavanju prostora (hladnijim)	l'efficienza energetica stagionale di riscaldamento (più fredde)	telpu apsildes sezona energoefektivitāte (aukstākos)
l	l'efficacité énergétique saisonnière pour le chauffage des locaux (plus chaudes)	sezonska energetska učinkovitost pri zagrijavanju prostora (toplijim)	l'efficienza energetica stagionale di riscaldamento (più calde)	telpu apsildes sezona energoefektivitāte (siltākos)
m	la consommation annuelle d'énergie (plus froides)	godišnja potrošnja energije (hladnijim)	il consumo annuo di energia (più fredde)	gada enerģijas patēriņš (aukstākos)
n	la consommation annuelle d'énergie (plus chaudes)	godišnja potrošnja energije (toplijim)	il consumo annuo di energia (più calde)	gada enerģijas patēriņš (siltākos)
o	L _{wa} (le niveau de puissance acoustique, à l'extérieur)	L _{wa} (razina zvučne snage, na otvorenom)	LWA (il livello di potenza sonora, all'esterno)	L _{wa} (akustiskās jaudas līmenis, ārpus telpām)
p	moyenne température	srednjim temperaturama	media temperatura	vidējais temperatūras
q	basse température	nisko temperatura	bassa temperatura	Zemas temperatūras
r	¹⁾ Des précautions, comme décrit dans le manuel d'installation/d'utilisation, doivent être prises lors du montage, de l'installation et de l'entretien de l'appareil.	¹⁾ Prilikom sastavljanja, instalacije i održavanja proizvoda potrebno je poduzeti mjere opreza navedene u priručniku za instalaciju / korisničkom priručniku.	¹⁾ Le precauzioni descritte nel manuale Installazione/utente devono essere rispettate in fase di montaggio, installazione e manutenzione del prodotto	¹⁾ Izstrādājuma salikšanas, uzstādīšanas un apkopes laikā jāievēro uzstādīšanas/lietošanas rokasgrāmātā norādītie piesardzības pasākumi.
s	l'efficacité énergétique saisonnière pour le chauffage des locaux (du dispositif de chauffage des locaux utilisé à titre principal)	sezonska energetska učinkovitost pri zagrijavanju prostora (primarnog grijača prostora)	l'efficienza energetica stagionale di riscaldamento (preferenziale per il riscaldamento)	telpu apsildes sezona energoefektivitāte (preferenciāli telpu sildītāja)
t	le coefficient de pondération de la puissance thermique du dispositif de chauffage utilisé à titre principal et du dispositif de chauffage d'appoint d'un produit combiné	težniski faktor toplinske snage primarnog ili dodatnih grijača u kompletu	il fattore di ponderazione della potenza termica degli apparecchi di riscaldamento preferenziali o supplementari di un insieme	koeficients komplekta preferenciāli un papildu sildītāja siltuma jaudas svērtās vērtības iegūšanai
u	l'expression mathématique : 294 / (11 + Prated) ¹⁾	matematičke formule : 294 / (11 + Prated) ¹⁾	espressione matematica : 294 / (11 + Prated) ¹⁾	matemātiskās izteiksmes : 294 / (11 + Prated) ¹⁾
v	l'expression mathématique : 115 / (11 + Prated) ²⁾	matematičke formule : 115 / (11 + Prated) ²⁾	espressione matematica : 115 / (11 + Prated) ²⁾	matemātiskās izteiksmes : 115 / (11 + Prated) ²⁾
w	la différence entre les efficacités énergétiques saisonnières pour le chauffage des locaux dans les conditions climatiques moyennes et plus froides ³⁾	razlike između sezonskih energetske učinkovitosti pri zagrijavanju prostora u prosječnim i hladnijim klimatskim uvjetima ³⁾	Differenza tra l'efficienza energetica stagionale del riscaldamento in condizioni climatiche medie e più fredde ³⁾	atšķirība starp telpu apsildes sezona energoefektivitāti vidējos un aukstākos apstākļos ³⁾
x	la différence entre les efficacités énergétiques saisonnières pour le chauffage des locaux dans les conditions climatiques plus chaudes et moyennes ⁴⁾	razlike između sezonskih energetske učinkovitosti pri zagrijavanju prostora u toplijim i prosječnim klimatskim uvjetima ⁴⁾	Differenza tra l'efficienza energetica stagionale del riscaldamento in condizioni climatiche più calde e medie ⁴⁾	atšķirība starp telpu apsildes sezona energoefektivitāti siltākos un vidējos apstākļos ⁴⁾
y	¹⁾ dans laquelle Prated renvoie au dispositif de chauffage des locaux utilisé à titre principal	¹⁾ pri čemu se Prated odnosi na primarni grijač prostora	¹⁾ dove Pnominale si riferisce all'apparecchio per il riscaldamento preferenziale	¹⁾ vērtība, kur Prated attiecas uz preferenciālo telpu sildītāju
z	²⁾ dans laquelle Prated renvoie au dispositif de chauffage des locaux utilisé à titre principal	²⁾ pri čemu se Prated odnosi na primarni grijač prostora	²⁾ dove Pnominale si riferisce all'apparato per il riscaldamento preferenziale	²⁾ vērtība, kur Prated attiecas uz preferenciālo telpu sildītāju
aa	³⁾ ⁴⁾ pour les dispositifs de chauffage des locaux par pompe à chaleur utilisés à titre principal	³⁾ ⁴⁾ za primarne toplinske crpke za grijanje prostora	³⁾ ⁴⁾ per gli apparati per il riscaldamento preferenziali a pompa di calore	³⁾ ⁴⁾ preferenciālajiem siltumsūkņiem telpu sildītājiem
ab	la classe du régulateur de température	razred uređaja za upravljanje temperaturom	la classe del dispositivo di controllo della temperatura	temperatūras regulatora klase
ac	la contribution du régulateur de température à l'efficacité énergétique saisonnière pour le chauffage des locaux	doprinos uređaja za upravljanje temperaturom sezonskoj energetskej učinkovitosti pri zagrijavanju prostora	il contributo del dispositivo di controllo della temperatura all'efficienza energetica stagionale di riscaldamento	temperatūras regulatora devums telpu apsildes sezona energoefektivitātē

No	Lithuanian(LT)	Hungarian(HU)	Maltese(MT)	Dutch(NL)
i	KOMISIJOS DELEGUOTASIS REGLAMENTAS (ES) Nr. 811/2013	A BIZOTTSÁG 811/2013/EU FELHATALMAZÁSON ALAPULÓ RENDELETE	REGOLAMENT TA' DEGAFA TAL-KUMMISSJONI (UE) Nru 811/2013	GEDELEGEEERDE VERORDENING (EU) Nr. 811/2013 VAN DE COMMISSIE
ii	Gaminio vardinų parametų lentelė (energijos vartojimo efektyvumo ženklinio dėl patalpų šildytuvo)	Termékismertető adatlap (energiafogyasztásának címkezése a helyiségfűtő berendezések)	L-iskeda tat-taġrif tal-prodott (tikkettar enerġetiku ta' hitters tal-post)	Productkaart (de energie-etikettering van ruimteverwarmingstoestellen)
iii	Gaminio vardinų parametų lentelė (energijos vartojimo efektyvumo ženklinio dėl patalpų šildytuvo, komplektu)	Termékismertető adatlap (energiafogyasztásának címkezése a helyiségfűtő berendezésből)	L-iskeda tat-taġrif tal-prodott (tikkettar enerġetiku ta' paketti magħmulin minn hitter tal-post)	Productkaart (de energie-etikettering van pakketten van ruimteverwarmingstoestellen)
iv	Gaminio vardinų parametų lentelė (energijos vartojimo efektyvumo ženklinio dėl temperatūros regulatoriaus)	Termékismertető adatlap (energiafogyasztásának címkezése a hőmérséklet-szabályozóból)	L-iskeda tat-taġrif tal-prodott (tikkettar enerġetiku ta' regulator tal-temperatura)	Productkaart (de energie-etikettering van temperatuurregelaars)
a	tiekėjo pavadinimas arba prekės ženklas	a beszállító neve vagy védjegye	isem il-fornitur jew il-marka kummerċjali tiegħu	de naam van de leverancier of het handelsmerk
b	tiekėjo modelio žymuo	a beszállító által megadott modellazonosító	l-identifikator tal-mudell tal-fornitur	de typeaanduiding van de leverancier
c	sezoninio energijos patalpoms šildyti vartojimo efektyvumo klasė	sezonális helyiségfűtési energiahatékonysági osztálya	il-klassi tal-effiċjenza enerġetika staġionali tat-tishin tal-post	de seizoensgebonden energie-efficiëntieklasse voor ruimteverwarming
d	vardinis šilumos atidavimas (vidutinio)	a mért hőteljesítmény (átlagos)	il-potenza termika nominali (medji)	de nominale warmteafgifte (gemiddelde)
e	sezoninis energijos patalpoms šildyti vartojimo efektyvumas (vidutinio)	a sezonális helyiségfűtési hatásfok (átlagos)	l-effiċjenza enerġetika staġionali tat-tishin tal-post (medji)	de seizoensgebonden energie-efficiëntie voor ruimteverwarming (gemiddelde)
f	metinis energijos suvartojimas (vidutinio)	az éves energiafogyasztás (átlagos)	il-konsum annwali tal-enerġija (medji)	het jaarlijkse energieverbruik (gemiddelde)
g	L _{wa} (garso galios lygis, patalpoje decibelais)	L _{wa} (hangteljesítményszint, beltén)	L _{wa} (il-livell ta' qawwa tal-hoss, fuq gawwa)	L _{wa} (het geluidsniveaugeniveau, binnen)
h	specialios atsargumo priemonės ¹⁾	külön óvintézkedések ¹⁾	prekawzjoni specifika ¹⁾	specifieke voorzorgsmaatregelen ¹⁾
i	vardinis šilumos atidavimas (šaltensnio)	a mért hőteljesítmény (hidegebb)	il-potenza termika nominali (ikсах)	de nominale warmteafgifte (koudere)
j	vardinis šilumos atidavimas (šiltensnio)	a mért hőteljesítmény (melegebb)	il-potenza termika nominali (iшan)	de nominale warmteafgifte (warmere)
k	sezoninis energijos patalpoms šildyti vartojimo efektyvumas (šaltensnio)	a sezonális helyiségfűtési hatásfok (hidegebb)	l-effiċjenza enerġetika staġionali tat-tishin tal-post (ikсах)	de seizoensgebonden energie-efficiëntie voor ruimteverwarming (koudere)
l	sezoninis energijos patalpoms šildyti vartojimo efektyvumas (šiltensnio)	a sezonális helyiségfűtési hatásfok (melegebb)	l-effiċjenza enerġetika staġionali tat-tishin tal-post (iшan)	de seizoensgebonden energie-efficiëntie voor ruimteverwarming (warmere)
m	metinis energijos suvartojimas (šaltensnio)	az éves energiafogyasztás (hidegebb)	il-konsum annwali tal-enerġija (ikсах)	het jaarlijkse energieverbruik (koudere)
n	metinis energijos suvartojimas (šiltensnio)	az éves energiafogyasztás (melegebb)	il-konsum annwali tal-enerġija (iшan)	het jaarlijkse energieverbruik (warmere)
o	L _{wa} (garso galios lygis, lauke decibelais)	L _{wa} (hangteljesítményszint, kültén)	L _{wa} (il-livell ta' qawwa tal-hoss, fuq barra)	L _{wa} (het geluidsniveaugeniveau, buiten)
p	vidutinėje temperatūroje	közepes hőmérsékletű	b'temperatura medja	middtemperatuur
q	žematemperatūris	alacsony hőmérsékletű	b'temperatura baxxa	lagetemperatuur
r	¹⁾ Montuojant ar įrengiant šį produktą, taip pat atliekant jo techninę priežiūrą, būtina atsisvegti į montavimo / naudojimo vadovė aprašytas atsargumo priemones.	¹⁾ A termék összeszerelése, telepítése és a karbantartása során tartsa be a telepítési/használati útmutatóban leírt óvintézkedéseket.	¹⁾ Prekawzjonijiet kif deskritti fl-installazzjoni u l-utent manwali għandhom jittiedha meta jaqqa l-installazzjoni, u z-żamma dan il-prodott	¹⁾ De voorzorgsmaatregelen die in de gebruikershandleiding worden beschreven, moeten in acht worden genomen bij montage, installatie en onderhoud van dit product.
s	sezoninis energijos patalpoms šildyti vartojimo efektyvumas (pirmiausia naudojamo patalpų šildytuvo)	a sezonális helyiségfűtési hatásfok (az elsődleges helyiségfűtő berendezés)	l-effiċjenza enerġetika staġionali tat-tishin tal-post (tat-tishin tal-post tal-hitter tal-post preferenzjali)	de seizoensgebonden energie-efficiëntie voor ruimteverwarming (ruimteverwarming van de hoofdverwarming)
t	komplekto pirmiausia naudojamo ir papildomo šildytuvų šilumos atidavimo švornis koeficientas	a csomagban található elsődleges és kiegészítő fűtőberendezések hőteljesítményének súlyozására szolgáló tényező	il-fattur għall-iżpezzar tal-potenza termika tal-hitters preferenzjali u tal-hitters supplementari tal-pakkett	de factor voor het wegen van de warmteafgifte van hoofd- en aanvullende verwarmingstoestellen van een pakket
u	matematinio reiškinio : 294 / (11 • Prated) ¹⁾	matematikai kifejezés : 294 / (11 • Prated) ¹⁾	tal-formola matematika : 294 / (11 • Prated) ¹⁾	de wiskundige formule : 294 / (11 • Prated) ¹⁾
v	matematinio reiškinio : 115 / (11 • Prated) ²⁾	matematikai kifejezés : 115 / (11 • Prated) ²⁾	tal-formola matematika : 115 / (11 • Prated) ²⁾	de wiskundige formule : 115 / (11 • Prated) ²⁾
w	sezoninio energijos patalpoms šildyti vartojimo efektyvum skirtumo vidutinio ir šaltensnio klimato sąlygomis ³⁾	az átlagos és a hidegebb éghajlati viszonyok mellett mért sezonális helyiségfűtési hatásfok közötti különbség ³⁾	tad-differenza bejn l-effiċjenza enerġetika staġionali tat-tishin tal-post f'kundizzjonijiet klimatiċi medji u dik f'kundizzjonijiet klimatiċi ikсах ³⁾	het verschil tussen de seizoensgebonden energie-efficiënties voor ruimteverwarming onder warmere en gemiddelde klimaatomstandigheden ³⁾
x	sezoninio energijos patalpoms šildyti vartojimo efektyvum skirtumo šiltensnio ir vidutinio klimato sąlygomis ⁴⁾	a melegebb és az átlagos éghajlati viszonyok mellett mért sezonális helyiségfűtési hatásfok közötti különbség ⁴⁾	tad-differenza bejn l-effiċjenza enerġetika staġionali tat-tishin tal-post f'kundizzjonijiet klimatiċi medji u dik f'kundizzjonijiet klimatiċi iшan ⁴⁾	het verschil tussen de seizoensgebonden energie-efficiënties voor ruimteverwarming onder gemiddelde en koudere klimaatomstandigheden ⁴⁾
y	¹⁾ kur Prated yra susijęs su pirmiausia naudojamu patalpų šildytuvu	¹⁾ ahol a Prated az elsődleges helyiségfűtő berendezésre vonatkozik	¹⁾ fejn il-valur ta' Prated huwa marbut mal-hitter tal-post preferenzjali	¹⁾ waarbij Prated is gerelateerd aan het ruimteverwarmingstoestel als hoofdverwarming
z	²⁾ kur Prated yra susijęs su pirmiausia naudojamu patalpų šildytuvu	²⁾ ahol a Prated az elsődleges helyiségfűtő berendezésre vonatkozik	²⁾ fejn il-valur ta' Prated huwa marbut mal-hitter tal-post preferenzjali	²⁾ waarbij Prated is gerelateerd aan het ruimteverwarmingstoestel als hoofdverwarming
aa	³⁾ , ⁴⁾ pirmiausia naudojamų patalpų šildytuvų su šilumos siurbliu	³⁾ , ⁴⁾ elsődleges hőszivattyús helyiségfűtő berendezések esetében	³⁾ , ⁴⁾ għall-hitters tal-post preferenzjali b'pompa tas-šana	³⁾ , ⁴⁾ voor ruimteverwarmingstoestellen met warmtepomp als hoofdverwarming
ab	temperatūros regulatoriaus klasė	a hőmérséklet-szabályozó osztálya	il-klassi tar-regulator tal-temperatura	de klasse van de temperatuurregelaar
ac	temperatūros regulatoriaus sandas sezoniniam energijos patalpoms šildyti vartojimo efektyvumui	a hőmérséklet-szabályozó sezonális helyiségfűtési hatásfokhoz való hozzájárulásának	il-kontribut tar-regulator tal-temperatura għall-effiċjenza enerġetika staġionali tat-tishin tal-post	de bijdrage van de temperatuurregelaar aan de seizoensgebonden energie-efficiëntie voor ruimteverwarming

COMMISSION DELEGATED REGULATION (EU) No 811/2013 ⁱ⁾

No	Polish(PL)	Portuguese(PT)	Romanian(RO)	Slovak(SK)
i	ROZPORZĄDZENIE DELEGOWANE KOMISJI (UE) NR 811/2013	REGULAMENTO DELEGADO (UE) Nº 811/2013 DA COMISSÃO	REGULAMENTUL DELEGAT AL COMISIEI (UE) NR. 811/2013	DELEGOVANÉ NARIADENÉ KOMISIE (EÚ) č. 811/2013
ii	Karta produktu (w odniesieniu do etykiet efektywności energetycznej dla ogrzewaczy pomieszczeń)	Ficha de produto (rotulagem energética dos aquecedores de ambiente)	Fișa produsului (ce privește clasa de energie a instalajilor pentru încălzirea incintelor)	Informačný list (energetické označovanie tepelných zdrojov na vykurovanie priestoru)
iii	Karta produktu (w odniesieniu do etykiet efektywności energetycznej dla zestawów zawierających ogrzewacz pomieszczeń)	Ficha de produto (rotulagem energética dos sistemas mistos de aquecedor de ambiente)	Fișa produsului (ce privește clasa de energie instalajilor pentru încălzirea incintelor)	Informačný list (energetické označovanie tepelných zdrojov na vykurovanie priestoru)
iv	Karta produktu (w odniesieniu do etykiet efektywności energetycznej dla regulatorów temperatury)	Ficha de produto (rotulagem energética dos dispositivos de controlo de temperatura)	Fișa produsului (ce privește etichetarea energetică a regulatorilor de temperatură)	Informačný list (energetické označovanie regulatorov teploty)
a	nazwa dostawcy lub jego znak towarowy	Nome do fornecedor	Denumirea sau marca comercială a furnizorului	meno dodávateľa alebo ochranná známka
b	identyfikator modelu dostawcy	Modelo	Modelul identificator al furnizorului	identifikačný kód modelu
c	klasa sezonowej efektywności energetycznej ogrzewania pomieszczeń	Classe de eficiência energética do aquecimento ambiente sazonal	Clasa de eficiență energetică sezonieră aferentă încălzirii incintelor	trieda sezónnej energetickej účinnosti vykurovania priestoru
d	Znamionowa moc cieplna (uśredniona)	Potência calorífica nominal (condições climáticas médias)	Puterea termică nominală (medie)	menovitý tepelný výkon (priemerný)
e	Sezonowa efektywność energetyczna ogrzewania pomieszczeń (uśredniona)	Eficiência energética do aquecimento ambiente sazonal (condições climáticas médias)	Eficiență energetică sezonieră aferentă încălzirii incintelor (medie)	sezónna energetická účinnosť vykurovania priestoru (priemerná)
f	Roczne zużycie energii (uśrednione)	Consumo anual de energia (condições climáticas médias)	Consumul anual de energie (medie)	ročná spotreba energie (priemerná)
g	LWA (poziom poziom akustycznej, w pomieszczeniu)	LWA (Nivel de potencia sonora, no interior)	LWA (nivelul de putere acustică, la interior)	LWA (hladina akustického výkonu, vnútorné jednotky)
h	Szczególne środki ostrożności ¹⁾	Precauções específicas ¹⁾	Măsură de precauție specifică ¹⁾	osobitné bezpečnostné opatrenie ¹⁾
i	znamionowa moc cieplna (chłodnego)	Potência calorífica nominal (condições climáticas mais frias)	Puterea termică nominală (mai reci)	menovitý tepelný výkon (chladnejší)
j	znamionowa moc cieplna (ciepłego)	Potência calorífica nominal (condições climáticas mais quentes)	Puterea termică nominală (mai calde)	menovitý tepelný výkon (teplejší)
k	sezonowa efektywność energetyczna ogrzewania pomieszczeń (chłodnego)	Eficiência energética do aquecimento ambiente sazonal (condições climáticas mais frias)	Eficiență energetică sezonieră aferentă încălzirii incintelor (mai reci)	sezónna energetická účinnosť vykurovania priestoru (chladnejší)
l	sezonowa efektywność energetyczna ogrzewania pomieszczeń (ciepłego)	Eficiência energética do aquecimento ambiente sazonal (condições climáticas mais quentes)	Eficiență energetică sezonieră aferentă încălzirii incintelor (mai calde)	sezónna energetická účinnosť vykurovania priestoru (teplejší)
m	roczne zużycie energii (chłodnego)	Consumo anual de energia (condições climáticas mais frias)	Consum anual de energie (mai reci)	ročná spotreba energie (chladnejší)
n	roczne zużycie energii (ciepłego)	Consumo anual de energia (condições climáticas mais quentes)	Consum anual de energie (mai calde)	ročná spotreba energie (teplejších)
o	LWA (poziom mocy akustycznej, na zewnątrz)	LWA (Nivel de potencia sonora, no exterior)	LWA (nivelul de putere acustică, la exterior)	LWA (hladina akustického výkonu, vonkajšie jednotky)
p	niskotemperaturowe	média temperatura	Temperatură medie	středná teplota
q	niskotemperaturowe	baixa temperatura	Temperatură scăzută	nízko teplotné
r	¹⁾ Podczas montażu, instalacji oraz serwisowaniu produktu należy stosować szczególne środki ostrożności zgodnie z informacjami zawartymi w instrukcji instalacji/podreczniku użytkownika.	¹⁾ As precauções descritas no manual de instalação/ instruções dever ser adotadas durante a montagem, instalação ou manutenção do produto.	¹⁾ Atenționări, descrise în manualul de instalare/ operare, ce trebuie luate în considerare când se asamblează, instalează sau întreține acest produs.	¹⁾ Bezpečnostné opatrenia, ktoré sú popísané v instalačnej/používateľskej príručke, sa musia vykonať pri inštalácii a údržbe tohto produktu.
s	sezonowa efektywność energetyczna ogrzewania pomieszczeń (podstawowego ogrzewacza pomieszczeń)	Eficiência energética do aquecimento ambiente sazonal (do aquecedor de ambiente preferencial)	Eficiență energetică sezonieră aferentă încălzirii incintelor (al instalației preferențiale pentru încălzirea incintelor)	sezónna energetická účinnosť vykurovania priestoru (uprednostňovaného tepelného zdroja na vykurovanie priestoru)
t	współczynnik ważący moc cieplną ogrzewaczy podstawowych oraz ogrzewaczy dodatkowych w zestawie	o fator de ponderação da potência calorífica do aquecedor preferencial e dos aquecedores complementares de um sistema misto	factorul de pondere a puterii termice a instalajilor de încălzire preferențiale și suplimentare din cadrul unui pachet	súčiniteľ na vázanie tepelného výkonu uprednostňovaného tepelného zdroja a dodatkových tepelných zdrojov
u	Wartość wyrażenia matematycznego : $294 / (11 \cdot Prated)$ ¹⁾	Expressão matemática : $294 / (11 \cdot Prated)$ ¹⁾	Valoarea expresiei matematice : $294 / (11 \cdot Prational)$ ¹⁾	matematický výraz : $294 / (11 \cdot Prated)$ ¹⁾
v	Wartość wyrażenia matematycznego : $115 / (11 \cdot Prated)$ ²⁾	Expressão matemática : $115 / (11 \cdot Prated)$ ²⁾	Valoarea expresiei matematice : $115 / (11 \cdot Prational)$ ²⁾	matematický výraz : $115 / (11 \cdot Prated)$ ²⁾
w	Różnica między sezonowymi efektywnościami energetycznymi ogrzewania pomieszczeń w warunkach klimatu umiarkowanego i chłodnego ³⁾	Diferença entre as eficiências energéticas do aquecimento ambiente sazonal em condições climáticas médias e em condições climáticas mais frias ³⁾	Diferența dintre eficiența energetică sezonieră aferentă încălzirii incintelor în condiții climatice medii și mai reci ³⁾	hodnota rozdielu sezónnych energetickej účinnosti vykurovania priestoru za priemerých a chladnejších podmienok ³⁾
x	Różnica między sezonowymi efektywnościami energetycznymi ogrzewania pomieszczeń w warunkach klimatu ciepłego i umiarkowanego ⁴⁾	Diferença entre as eficiências energéticas do aquecimento ambiente sazonal em condições climáticas mais quentes e em condições climáticas médias ⁴⁾	Diferența dintre eficiența energetică sezonieră aferentă încălzirii incintelor în condiții climatice calde și medii ⁴⁾	hodnota rozdielu sezónnych energetickej účinnosti vykurovania priestoru za teplejších a priemerých podmienok ⁴⁾
y	¹⁾ gdzie Prated dotyczy podstawowego ogrzewacza pomieszczeń	¹⁾ em que Prated diz respeito ao aquecedor de ambiente preferencial	¹⁾ Unde Prational se referă la instalația preferențială pentru încălzirea incintelor.	¹⁾ kde Prated súvisí s uprednostňovaným tepelným zdrojom na vykurovanie priestoru
z	²⁾ gdzie Prated dotyczy podstawowego ogrzewacza pomieszczeń	²⁾ em que Prated diz respeito ao aquecedor de ambiente preferencial	²⁾ Unde Prational se referă la instalația preferențială pentru încălzirea incintelor.	²⁾ kde Prated súvisí s uprednostňovaným tepelným zdrojom na vykurovanie priestoru
aa	³⁾ ⁴⁾ Dla podstawowych ogrzewaczy pomieszczeń z pompą ciepłą	³⁾ ⁴⁾ para os aquecedores de ambiente preferenciais com bomba de calor	³⁾ ⁴⁾ Pentru instalabile preferențiale cu pompă de căldură pentru încălzirea incintelor.	³⁾ ⁴⁾ pre uprednostňované tepelné zdroje na vykurovanie priestoru – tepelné čerpadlá
ab	klasa regulatora temperatury	A classe do dispositivo de controlo de temperatura	Clasa regulatorului de temperatură	trieda regulatora teploty
ac	udział regulatora temperatury w sezonowej efektywności energetycznej ogrzewania pomieszczeń	A contribuição do dispositivo de controlo de temperatura para a eficiência energética do aquecimento ambiente sazonal	Contribuția regulatorului de temperatură la eficiența energetică sezonieră aferentă încălzirii incintelor	príspevok regulatora teploty k sezónnej energetickej účinnosti vykurovania priestoru

No	Slovenian(SL)	Finnish(FI)	Swedish(SV)
i	DELEGIIRANA UREDBA KOMISJE (EU) št. 811/2013	KOMISSION DELEGOITU ASETUS (EU) N:o 811/2013	KOMMISSIONENS DELEGERADE FÖRORDNING (EU) nr 811/2013
ii	Podatkovni list izdelka (energijskega označevanja grelnikov prostorov)	Tuoteseloste (tilälämmittimien, energiamerkinnän)	Produktblad (energimärkning av pannor och värmepumpar för rumsuppvärmning)
iii	Podatkovni list izdelka (energijskega označevanja kompletoval grelnika prostorov)	Tuoteseloste (tilälämmittimestä, energiamerkinnän)	Produktblad (energimärkning av paket med pannor och värmepumpar för rumsuppvärmning)
iv	Podatkovni list izdelka (energijskega označevanja naprave za uravnavanje temperature)	Tuoteseloste (lämmönsäätölaitteista, energiamerkinnän)	Produktblad (energimärkning av temperaturregulator)
a	dobaviteljeva ime ali blagovna znamka	tavarantoimittajan nimi tai tavaramerkki	Leverantörens namn eller varumärke
b	dobaviteljeva identifikacijska oznaka modela	tavarantoimittajan mallitunniste	Leverantörens modellbeteckning
c	razred sezonske energijske učinkovitosti pri ogrevanju prostorov	tilälämmityksen kausittainen energiatehokkuusluokka	säsongrelaterade energieffektivitetsklass vid rumsuppvärmning
d	nazivna izhodna toplota (povprečnih)	nimellislämpöteho, mukaan lukien mahdollisen lisälämmittimen nimellislämpöteho (keskimääräisissä)	Den nominella avgivna värmeeffekten (genomsnittliga)
e	sezonska energijska učinkovitost pri ogrevanju prostorov (povprečnih)	tilälämmityksen kausittainen energiatehokkuus (keskimääräisissä)	Säsongmedelverkningsgrad för rumsuppvärmning (genomsnittliga)
f	letna poraba energije (povprečnih)	vuotuinen energiankulutus (keskimääräisissä)	Årlig energiförbrukning (genomsnittliga)
g	L_{w} (raven zvočne moči, notranja)	L_{w} (äänitehotas, sisällä desibeleinä)	L_{w} (ljudeffektivit, inomhus)
h	posebni varnostni ukrepi ¹⁾	erityiset varotoimenpiteet ¹⁾	särskilda försiktighetsåtgärder ¹⁾
i	nazivna izhodna toplota (hladnejših)	nimellislämpöteho, mukaan lukien mahdollisen lisälämmittimen nimellislämpöteho (kylmissä)	Den nominella avgivna värmeeffekten (kallare)
j	nazivna izhodna toplota (toplejših)	nimellislämpöteho, mukaan lukien mahdollisen lisälämmittimen nimellislämpöteho (lämpimissä)	Den nominella avgivna värmeeffekten (varmare)
k	sezonska energijska učinkovitost pri ogrevanju prostorov (hladnejših)	tilälämmityksen kausittainen energiatehokkuus (kylmissä)	Säsongmedelverkningsgrad för rumsuppvärmning (kallare)
l	sezonska energijska učinkovitost pri ogrevanju prostorov (toplejših)	tilälämmityksen kausittainen energiatehokkuus (lämpimissä)	Säsongmedelverkningsgrad för rumsuppvärmning (varmare)
m	letna poraba energije (hladnejših)	vuotuinen energiankulutus (kylmissä)	Årlig energiförbrukning (kallare)
n	letna poraba energije (toplejših)	vuotuinen energiankulutus (lämpimissä)	Årlig energiförbrukning (varmare)
o	L_{w} (raven zvočne moči, zunanja)	L_{w} (äänitehotas, ulkona desibeleinä)	L_{w} (ljudeffektivit, utomhus)
p	средnjih temperaturah	keskilämpötilan	mediumtemperatur
q	nizkotemperaturna	matalan lämpötilan	lågtemperatur
r	¹⁾ Pri sestavljanju, nameščanju ter vzdrževanju izdelka upoštevajte previdnostne ukrepe, ki so navedeni v priročniku za uporabo in namestitve.	¹⁾ Asennus- tai käyttöoppaassa kuvattuja turvaohjeita on noudatettava laitteen kokoamisen, asentamisen ja huollon aikana.	¹⁾ Försiktighetsåtgärderna som beskrivs i installationsmanualen/bruksanvisningen måste följas vid monteringen, installation och underhåll av denna produkt.
s	sezonska energijska učinkovitost pri ogrevanju prostorov (za prednostni grelnik prostorov)	tilälämmityksen kausittainen energiatehokkuus (ensisijaisen tilälämmittimen tilälämmityksen)	Säsongmedelverkningsgrad för rumsuppvärmning (primära pannans eller värmepumpens)
t	ensisijaisen lämmittimen ja lisälämmittimen lämpötehon painotuskertoin	ensisijaisen lämmittimen ja lisälämmittimen lämpötehon painotuskertoin	Viktningfaktor för primär- och tillsatsvärmarens värmeproduktion för paket
u	matematične enačbe : $294 / (11 \cdot Prated)$ ¹⁾	matemaattisen ilmaisen : $294 / (11 \cdot Prated)$ ¹⁾	matematiska formeln : $294 / (11 \cdot Prated)$ ¹⁾
v	matematične enačbe : $115 / (11 \cdot Prated)$ ²⁾	matemaattisen ilmaisen : $115 / (11 \cdot Prated)$ ²⁾	matematiska formeln : $115 / (11 \cdot Prated)$ ²⁾
w	razlike med sezonskima energijskima učinkovitostma pri ogrevanju prostorov v povprečnih in hladnejših podnebni razmerah ³⁾	keskimääräisissä ja kylmissä ilmasto-olosuhteissa saavutettavien tilälämmityksen kausittaisten energiatehokkuuksien ero ³⁾	Skillnaden mellan den säsongrelaterade energieffektiviteten vid rumsuppvärmning under genomsnittliga och kallare klimatförhållanden ³⁾
x	razlike med sezonskima energijskima učinkovitostma pri ogrevanju prostorov v toplejših in povprečnih podnebni razmerah ⁴⁾	lämpimissä ja keskimääräisissä ilmasto-olosuhteissa saavutettavien tilälämmityksen kausittaisten energiatehokkuuksien ero ⁴⁾	Skillnaden mellan den säsongrelaterade energieffektiviteten vid rumsuppvärmning under varmare och genomsnittliga klimatförhållanden ⁴⁾
y	¹⁾ pri čemer se Prated navezuje na prednostni grelnik prostorov	¹⁾ jossa Prated liittyy ensisijaiseen tilälämmittimeen	¹⁾ där Prated är relaterat till den primära pannan eller värmepumpen
z	²⁾ pri čemer se Prated navezuje na prednostni grelnik prostorov	²⁾ jossa Prated liittyy ensisijaiseen tilälämmittimeen	²⁾ där Prated är relaterat till den primära pannan eller värmepumpen
aa	³⁾ , ⁴⁾ prednostne toplotne čpalke za ogrevanje prostorov	³⁾ , ⁴⁾ ensisijaisista lämpöpumpputilälämmittimistä	³⁾ , ⁴⁾ för primära värmare med värmepump för rumsuppvärmning
ab	razred naprave za uravnavanje temperature	lämmönsäätölaitteen luokka	Temperaturregulatorns klass
ac	prispevek naprave za uravnavanje temperature k sezonski energijski učinkovitosti pri ogrevanju prostorov	lämmönsäätölaitteen vaikutus tilälämmityksen kausittaiseen energiatehokkuuteen	Temperaturregulatorns bidrag till säsongmedelverkningsgraden för rumsuppvärmning

SAMSUNG

SAMSUNG ELECTRONICS CO., LTD.

107, Hanamsandan 6beon-ro, Gwangsan-gu, Gwangju-si, Korea 62218

Samsung Electronics (UK) Ltd, Euro QA Lab.

Blackbushe Business Park, Saxony Way, Yateley, Hampshire. GU46 6GG United Kingdom